



riverstone®



www.riverstone.it

Indice

04	About Us
08	Made in Italy
10	Sostenibilità
12	Piatti doccia
56	Bordi piatti doccia
57	Tagli piatti doccia
58	Accessori piatti doccia
60	Lavabi
129	Accessori lavabi
130	Pannelli da rivestimento
134	Sezione Tecnica

About us

riverstone®

Riverstone è il marchio commerciale nato nel 1999 da Effepimarmi che identificava un materiale composto da sassolini naturali immersi in resina trasparente o colorata, che offriva un'estetica unica a "letto di fiume". Oggi il marchio Riverstone è associato alla nuova linea di piatti doccia e lavabi di Poliflex, una collezione che unisce design naturale e alte prestazioni tecniche, diventando una scelta distintiva e funzionale per ambienti moderni e raffinati.



La nostra sede produttiva e amministrativa si trova a Casciana Terme (PI), dove realizziamo internamente l'intero ciclo produttivo: dalla progettazione alla finitura, fino alla logistica.

La gamma comprende piatti doccia in diverse texture, formati e colori (anche su misura o con personalizzazione RAL/NCS) e lavabi disponibili in varie tipologie e finiture.

Grazie a un'organizzazione snella e ad una produzione flessibile, assicuriamo

tempi di consegna certi, oltre 100.000 piatti doccia e 20.000 lavabi prodotti ogni anno, e un servizio affidabile che ci rende partner ideale per professionisti e aziende del settore arredo bagno. Con un team di circa 80 persone e una superficie produttiva di 9.000 mq, Poliflex coniuga artigianalità e innovazione, offrendo soluzioni che nascono da un'attenta selezione dei materiali e da una costante ricerca tecnica ed estetica.

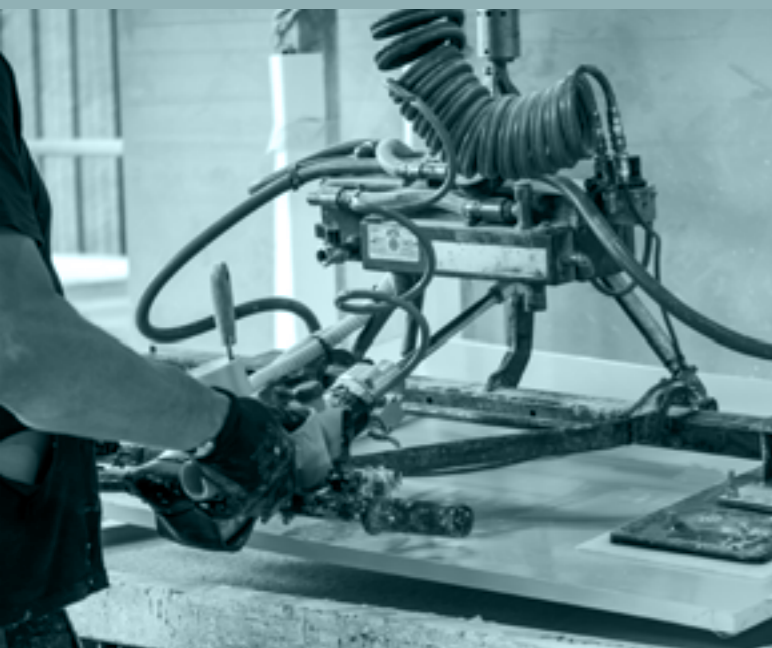

Poliflex Srl è un'azienda italiana specializzata nella produzione di componenti per l'arredo bagno in materiali compositi. Da oltre trent'anni operiamo con passione e competenza nel settore, offrendo soluzioni su misura e prodotti progettati per rispondere alle esigenze di funzionalità, design e durata nel tempo.



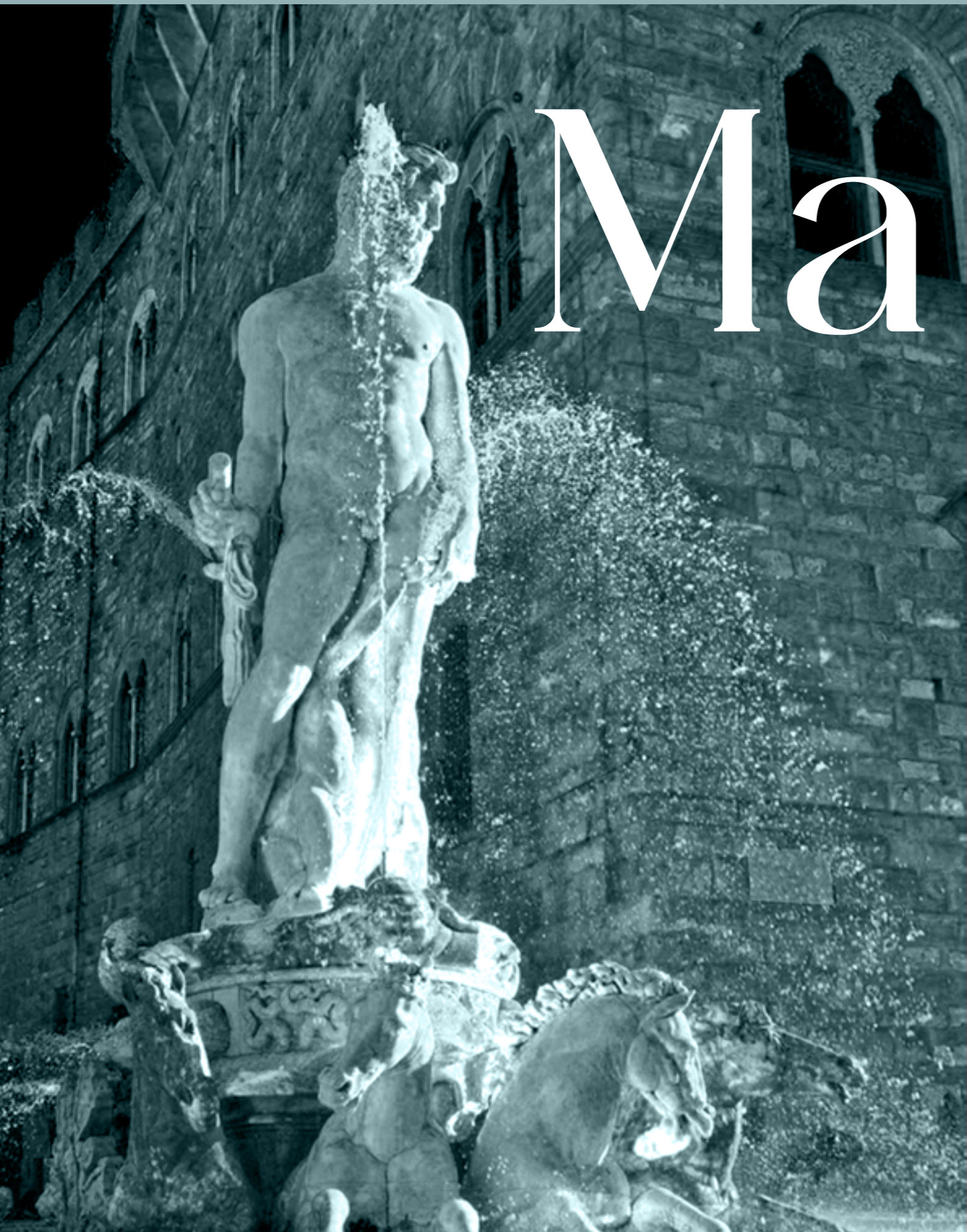

Ma

de

in

Italy

La collezione Riverstone è molto più che una gamma di lavabi e piatti doccia: è una filosofia che libera lo spazio.

È una nuova soluzione che vi consentirà di realizzare il bagno ritagliato intorno alle vostre esigenze.

Design, misure, colori, texture: molteplici varianti che ci offrono possibilità di personalizzare e adattare gli spazi sviluppando molteplici soluzioni. Spazi creativi dove trovare la soluzione migliore e sfruttare al meglio lo spazio

a disposizione, integrando piatti doccia, lavelli e pannelli per rivestimento.

Un'ampia gamma di prodotti adattabili a qualsiasi soluzione per il tuo bagno.

Sostenibilità

Riverstone progetta e realizza i propri prodotti utilizzando una combinazione innovativa di resine cariche minerali, una scelta tecnica che consente di ottenere materiali dalle elevate prestazioni meccaniche e funzionali.

70%

Carbonato di calcio puro

30%

Resina poliestere insatura

100%

Materiali di alta qualità

Questo mix accuratamente bilanciato rappresenta il cuore tecnologico della produzione Riverstone, permettendo di creare superfici compatte, solide e al tempo stesso flessibili, ideali per resistere nel tempo alle sollecitazioni quotidiane.

A valorizzare ulteriormente il prodotto finale è l'applicazione di un rivestimento in Gelcoat di altissima qualità, una finitura che svolge una duplice funzione: da un lato aumenta la resistenza a urti, graffi e agenti chimici; dall'altro migliora l'estetica complessiva, conferendo

alla superficie una brillantezza e una sensazione tattile piacevole e raffinata. Il risultato di questo processo è un prodotto finale che si distingue per durata, resistenza e bellezza. Ogni elemento firmato Riverstone nasce da un know-how tecnico avanzato, da una continua ricerca sui materiali e da una visione orientata all'eccellenza, garantendo così soluzioni affidabili, performanti e adatte alle esigenze del bagno contemporaneo.



Piatti Doccia

- 14 Danubio
- 20 Tamigi
- 26 Senna
- 32 Arno
- 36 Tevere cemento
- 44 Tevere soft
- 50 Reno
- 56 Bordi
- 57 Tagli
- 58 Accessori

Danubio

TEXTURE



ARDESIA

COLORI STANDARD



ANTRACITE
RAL 7043



URBAN
RAL 7006



TORTORA
RAL 1019



SABBIA
RAL 1013



GRIGIO
RAL 7047



BIANCO
RAL 9003

COLORI CUSTOM



RAL / NCS



Danubio

Superficie antiscivolo effetto ARDESIA.
Scarico laterale piccolo con coperchio in resina.
Piletta di scarico speciale rettangolare.
Disponibile in varie misure.

MISURE STANDARD

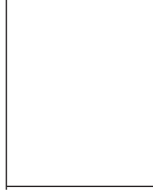
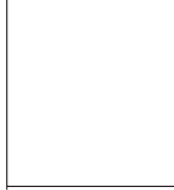
70 x	80 x	90 x
		
100	100	100
120	120	120
140	140	140
150	150	150
160	160	160
170	170	170
180	180	180
200	200	160



Danubio Sezione Tecnica

Dimensioni (cm)

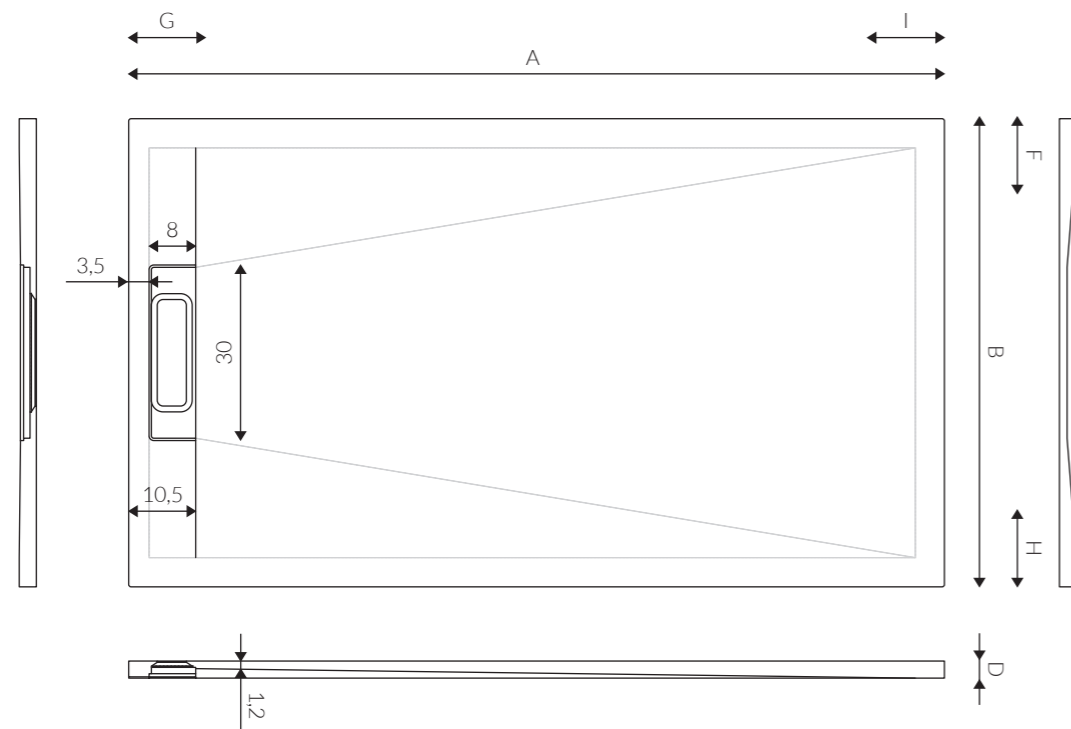

B 70						B 80						B 90					
A	D	G	I	F	H	A	D	G	I	F	H	A	D	G	I	F	H
100	2,5	0	10	0	0	100	2,5	0	10	0	0	100	2,5	0	0	0	0
120	2,5	0	20	0	0	120	2,5	0	20	0	0	120	2,5	0	0	0	0
140	2,7	0	20	0	0	140	2,7	0	20	0	0	140	2,7	0	10	0	0
150	2,9	0	10	0	0	150	2,9	0	10	0	0	150	2,9	0	10	0	0
160	2,9	0	20	0	0	160	2,9	0	20	0	0	160	2,9	0	20	0	0
170	2,9	0	10	0	0	170	2,9	0	10	0	0	-	-	-	-	-	-
180	3,0	0	20	0	0	180	3,0	0	20	0	0	-	-	-	-	-	-
200	3,0	0	20	0	0	200	3,0	0	20	0	0	-	-	-	-	-	-

Scarichi (mm)

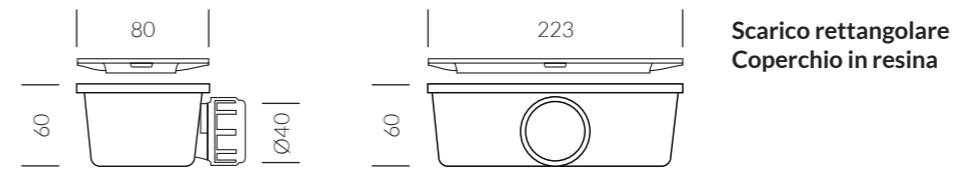

La piletta va sempre posizionata lato muro.

Tagli su misura

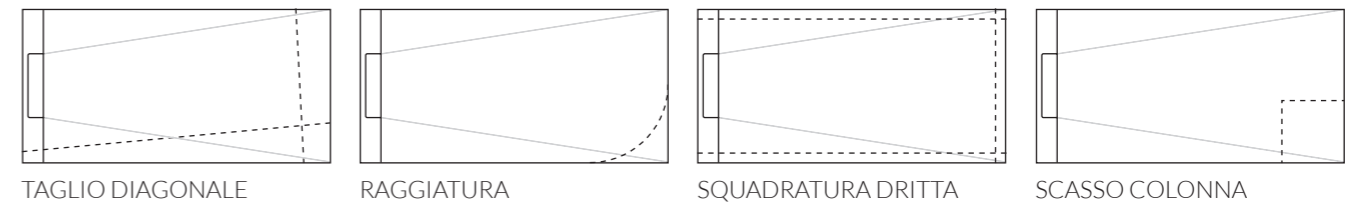

Bordi

Spessore bordo 4 cm

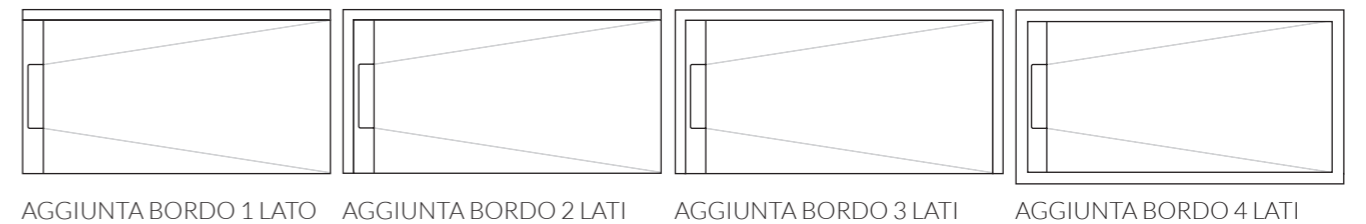

Zoccoli per piatti a gradino

Spessore su misura

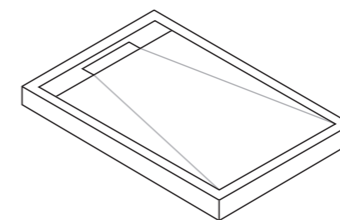

Classe antiscivolo

Normativa DIN 51097: A+B+C

Note

Le immagini sono da intendersi a scopo illustrativo e non costituiscono vincolo contrattuale. In caso di installazione di box doccia walk-in, con almeno un lato aperto, è consigliata l'aggiunta di un bordo per limitare la fuoriuscita d'acqua. Maggiori informazioni sono disponibili nella sezione "Bordi".

Tamigi

TEXTURE



ARDESIA

COLORI STANDARD



ANTRACITE
RAL 7043



URBAN
RAL 7006



TORTORA
RAL 1019



SABBIA
RAL 1013



GRIGIO
RAL 7047



BIANCO
RAL 9003

COLORI CUSTOM











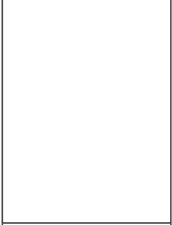

RAL / NCS



Tamigi

Superficie antiscivolo effetto ARDESIA.
Scarico laterale piccolo con coperchio in resina.
Piletta di scarico speciale rettangolare.
Disponibile in varie misure.

MISURE STANDARD

80 x		90 x	
	120		120
	140		140
	150		150
	160		160
	180		180
	200		200

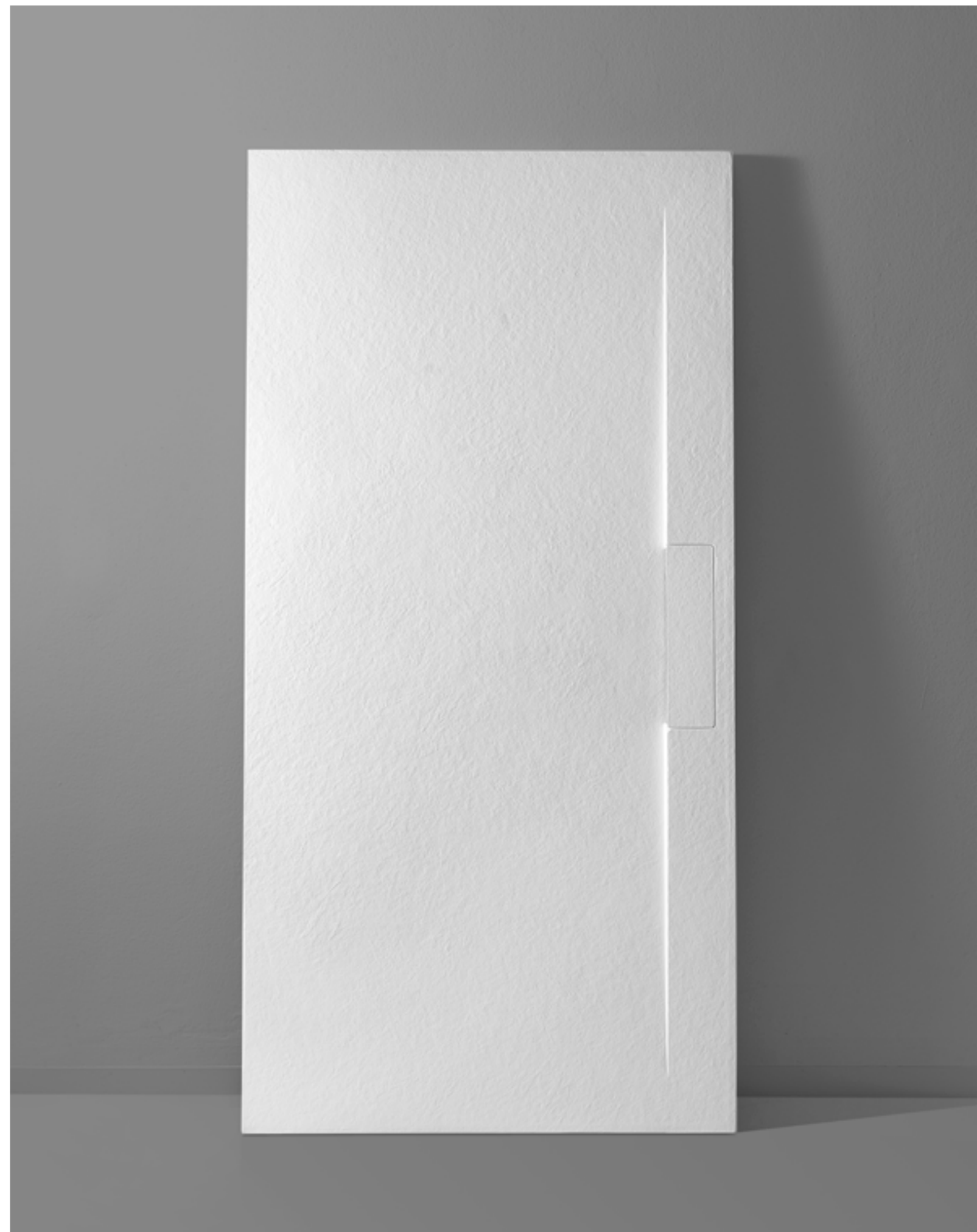
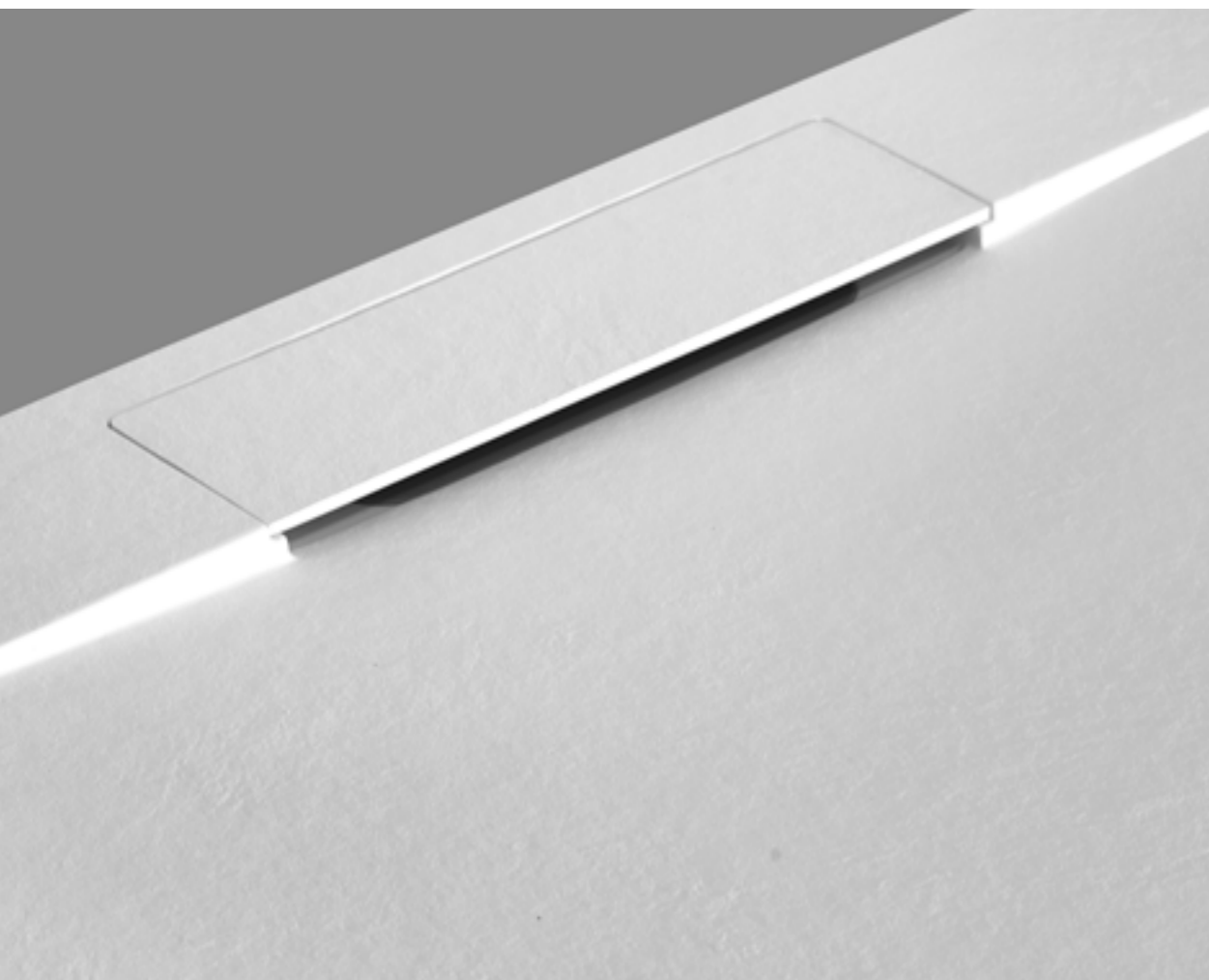

Tamigi Sezione Tecnica

Dimensioni (cm)

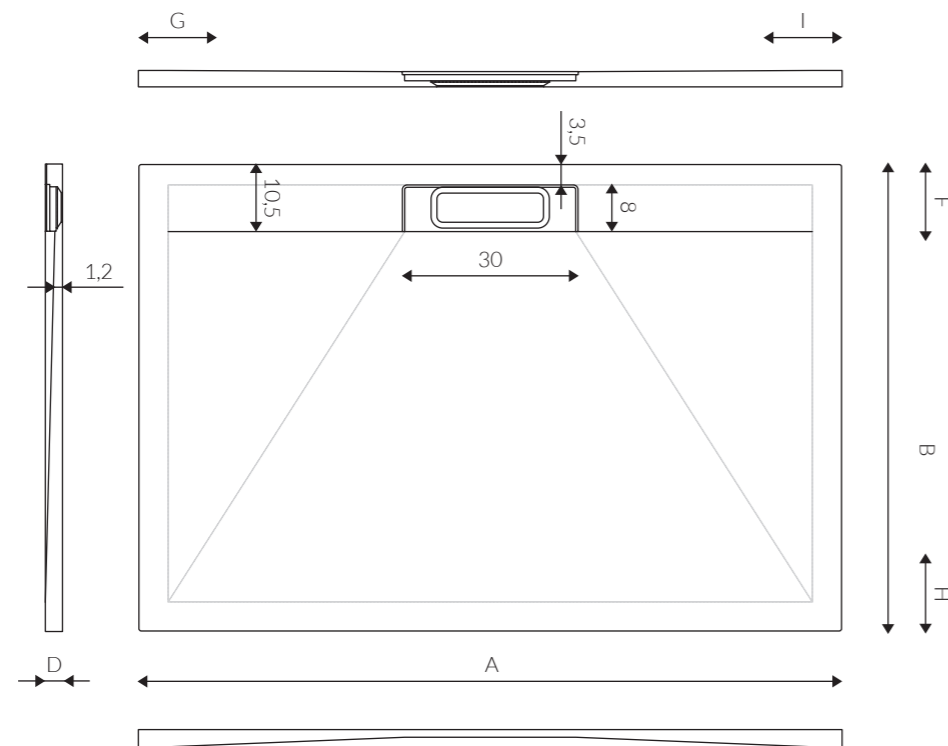

B 80						B 90					
A	D	G	I	F	H	A	D	G	I	F	H
120	2,5	5	5	0	5	120	2,5	5	5	0	5
140	2,7	5	5	0	5	140	2,7	5	5	0	5
150	2,7	-	-	0	5	150	2,7	-	-	0	5
160	2,9	5	5	0	5	160	2,9	5	5	0	5
180	3,0	5	5	0	5	180	3,0	5	5	0	5
200	3,0	5	5	0	5	200	3,0	5	5	0	5

Scarichi (mm)

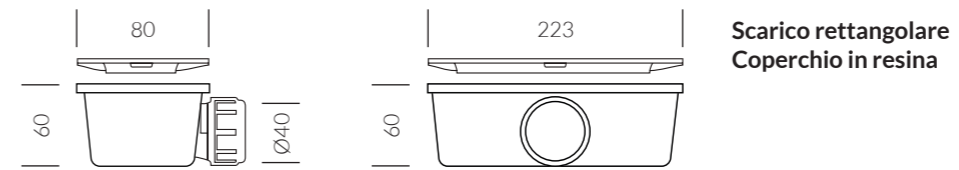

Scarico rettangolare
Coperchio in resina

La piletta va sempre posizionata lato muro.

Tagli su misura

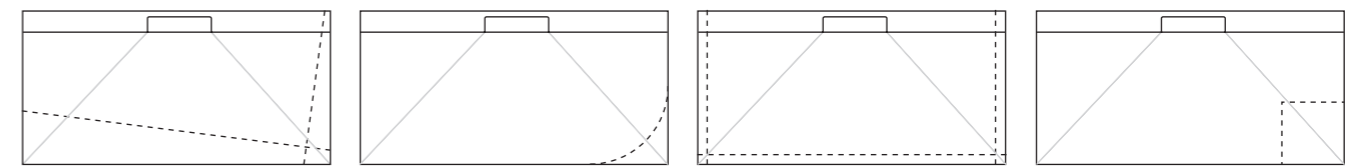

TAGLIO DIAGONALE

RAGGIATURA

SQUADRATURA DRITTA

SCASSO COLONNA

Bordi

Spessore bordo 4 cm

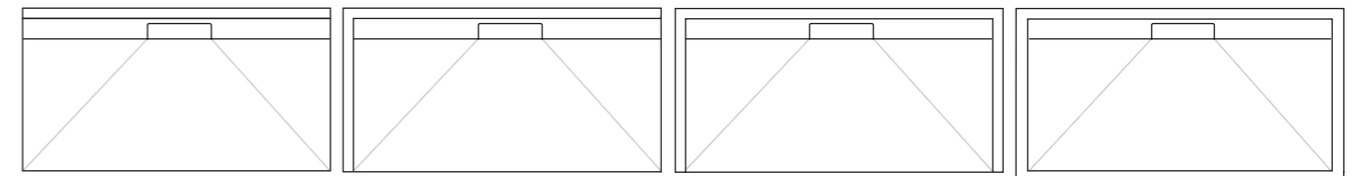

AGGIUNTA BORDO 1 LATO

AGGIUNTA BORDO 2 LATI

AGGIUNTA BORDO 3 LATI

AGGIUNTA BORDO 4 LATI

Zoccoli per piatti a gradino

Spessore su misura

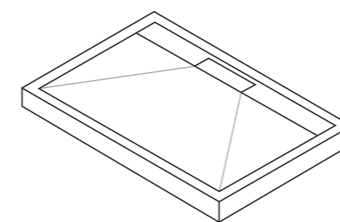

Classe antiscivolo

Normativa DIN 51097: A+B+C

Note

Le immagini sono da intendersi a scopo illustrativo e non costituiscono vincolo contrattuale. In caso di installazione di box doccia walk-in, con almeno un lato aperto, è consigliata l'aggiunta di un bordo per limitare la fuoriuscita d'acqua. Maggiori informazioni sono disponibili nella sezione "Bordi".

Senna

TEXTURE



PIETRA

COLORI STANDARD



ANTRACITE
RAL 7043



URBAN
RAL 7006



TORTORA
RAL 1019



SABBIA
RAL 1013



GRIGIO
RAL 7047



BIANCO
RAL 9003

COLORI CUSTOM



RAL / NCS



Senna

Superficie antiscivolo effetto PIETRA.





Scarico in posizione decentrata.

Piletta standard diametro 9 cm.

Disponibile in una gamma di misure molto ampia per garantire la massima adattabilità.

Può essere tagliato su 4 lati.

MISURE STANDARD

70 x	80 x	90 x	100 x
			
80	80	90	100
90	90	100	110
100	100	110	120
110	110	120	130
120	120	130	140
130	130	140	150
140	140	150	160
150	150	160	170
160	160	170	180
170	170	180	190
180	180	190	200
190	190	200	
200	200		

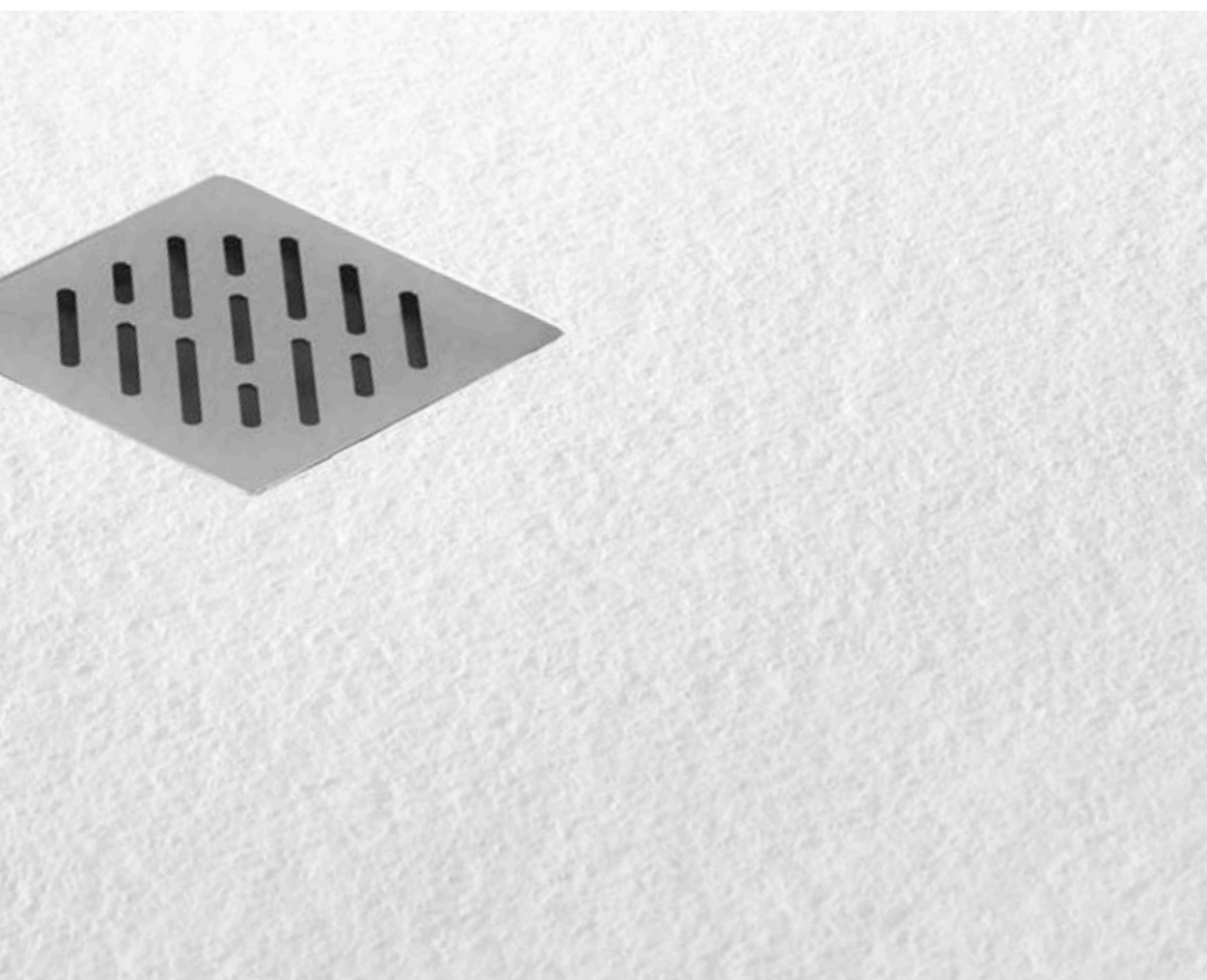

GRIGLIA

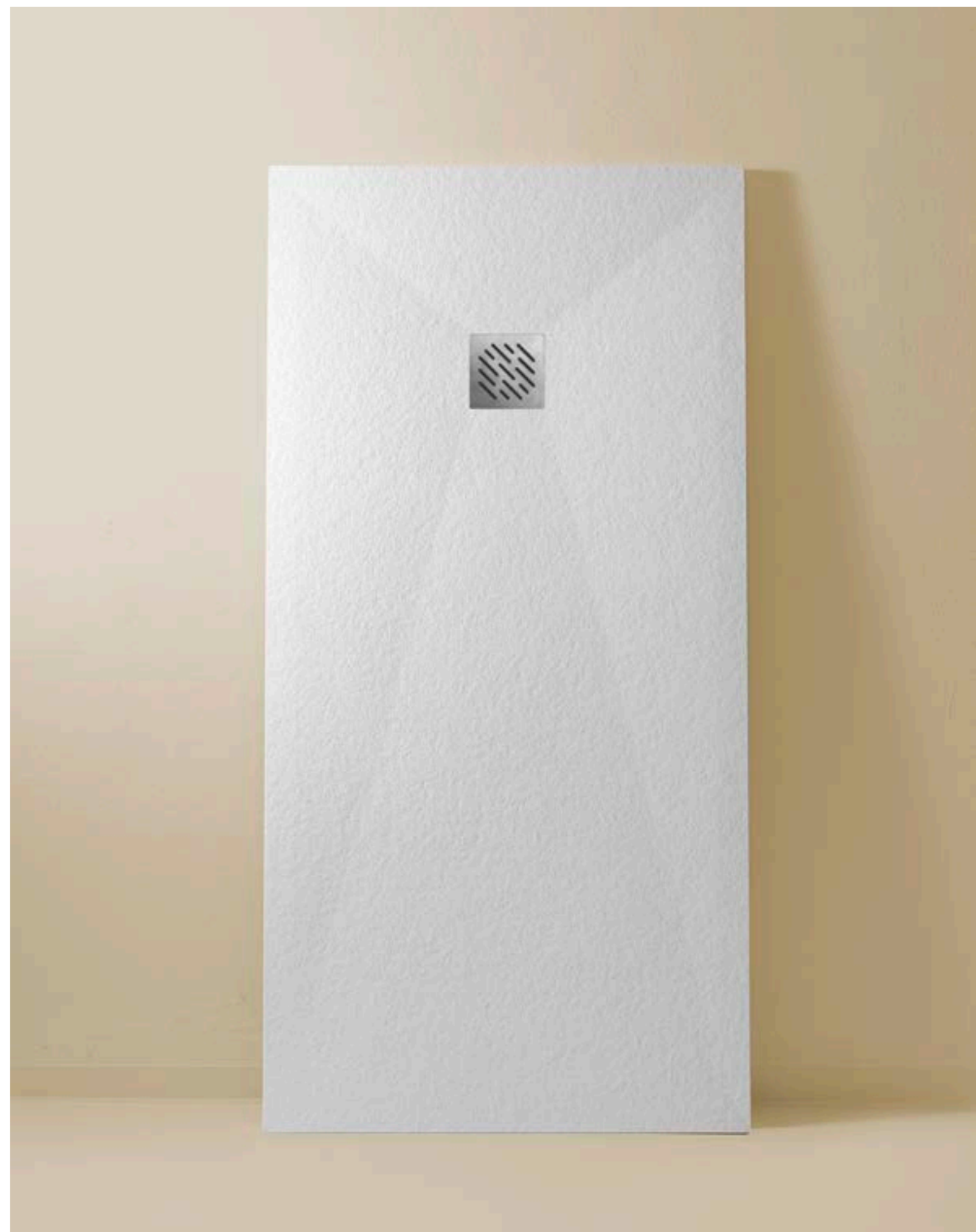
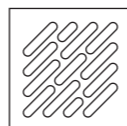

Senna Sezione Tecnica

Dimensioni (cm)

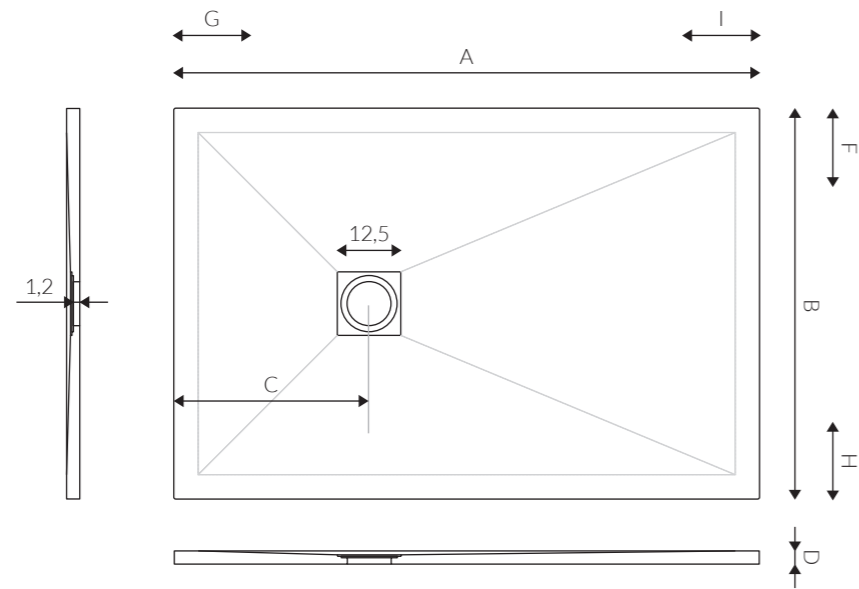

B 70							B 80						
A	C	D	G	I	F	H	A	C	D	G	I	F	H
80	35	2,7	5	10	5	5	80	40	2,7	5	10	5	5
90	35	2,7	5	10	5	5	90	35	2,7	5	10	5	5
100	35	2,7	5	10	5	5	100	35	2,7	5	10	5	5
110	35	2,7	5	10	5	5	110	35	2,7	5	10	5	5
120	35	2,7	5	10	5	5	120	35	2,7	5	10	5	5
130	35	2,7	5	10	5	5	130	35	2,7	5	10	5	5
140	35	2,7	5	10	5	5	140	35	2,7	5	10	5	5
150	35	2,7	5	10	5	5	150	35	2,7	5	10	5	5
160	35	2,7	5	10	5	5	160	35	2,7	5	10	5	5
170	50	2,7	5	10	5	5	170	50	2,7	5	10	5	5
180	50	2,7	5	10	5	5	180	50	2,7	5	10	5	5
190	50	2,7	5	10	5	5	190	50	2,7	5	10	5	5
200	50	3,2	5	10	5	5	200	50	3,2	5	10	5	5
B 90							B 100						
A	C	D	G	I	F	H	A	C	D	G	I	F	H
90	45	2,7	5	10	5	5	-	-	-	-	-	-	-
100	35	2,7	5	10	5	5	100	35	2,7	5	10	5	5
110	35	2,7	5	10	5	5	-	-	-	-	-	-	-
120	35	2,7	5	10	5	5	120	35	2,7	5	20	5	5
130	35	2,7	5	10	5	5	-	-	-	-	-	-	-
140	35	2,7	5	10	5	5	140	35	2,7	5	20	5	5
150	35	2,7	5	10	5	5	150	50	2,7	5	10	5	5
160	35	2,7	5	10	5	5	160	50	2,7	5	10	5	5
170	50	2,7	5	10	5	5	-	-	-	-	-	-	-
180	50	2,7	5	10	5	5	180	50	2,7	5	20	5	5
190	50	2,7	5	10	5	5	-	-	-	-	-	-	-
200	50	2,7	5	10	5	5	200	50	2,7	5	20	5	5

Griglia

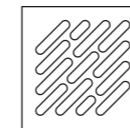

Misura	INOX	STANDARD	RAL / NCS
12,5 x 12,5 cm	✓	✓	✓

Scarichi (mm)

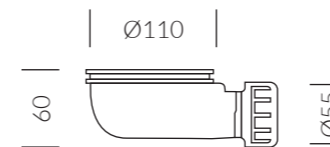

Scarico standard
La piletta va sempre posizionata lato muro.

Tagli su misura

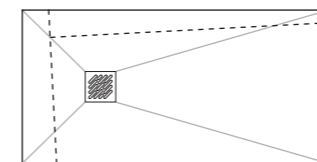

TAGLIO DIAGONALE

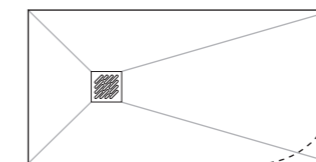

RAGGIATURA

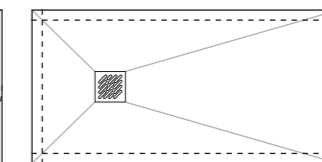

SQUADRATURA DRITTA

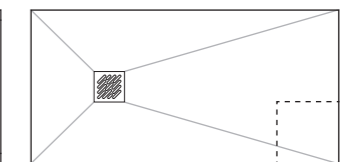

SCASSO COLONNA

Bordi

Spessore bordo 4 cm

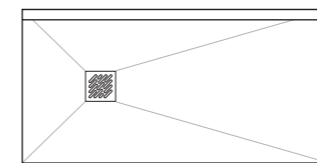

AGGIUNTA BORDO 1 LATO

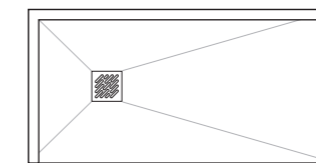

AGGIUNTA BORDO 2 LATI

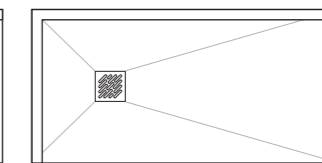

AGGIUNTA BORDO 3 LATI

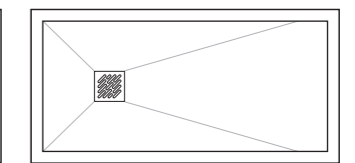

AGGIUNTA BORDO 4 LATI

Zoccoli per piatti a gradino

Spessore su misura

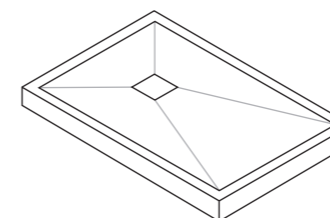

Classe antiscivolo

Normativa DIN 51097: A+B+C

Note

Le immagini sono da intendersi a scopo illustrativo e non costituiscono vincolo contrattuale. In caso di installazione di box doccia walk-in, con almeno un lato aperto, è consigliata l'aggiunta di un bordo per limitare la fuoriuscita d'acqua. Maggiori informazioni sono disponibili nella sezione "Bordi".

Arno

TEXTURE



DOLOMITE

COLORI STANDARD



ANTRACITE
RAL 7043



URBAN
RAL 7006



TORTORA
RAL 1019



SABBIA
RAL 1013



GRIGIO
RAL 7047



BIANCO
RAL 9003

COLORI CUSTOM



RAL / NCS



Arno

Superficie antiscivolo effetto DOLOMITE.





Scarico in posizione decentrata.

Piletta standard diametro 9 cm.

Disponibile in una gamma di misure molto ampia per garantire la massima adattabilità.

Può essere tagliato su 4 lati.

MISURE STANDARD

70 x	80 x	90 x	100 x
			
80	80	90	100
90	90	100	110
100	100	110	120
110	110	120	130
120	120	130	140
130	130	140	150
140	140	150	160
150	150	160	170
160	160	170	180
170	170	180	190
180	180	190	200
190	190	200	
200	200		

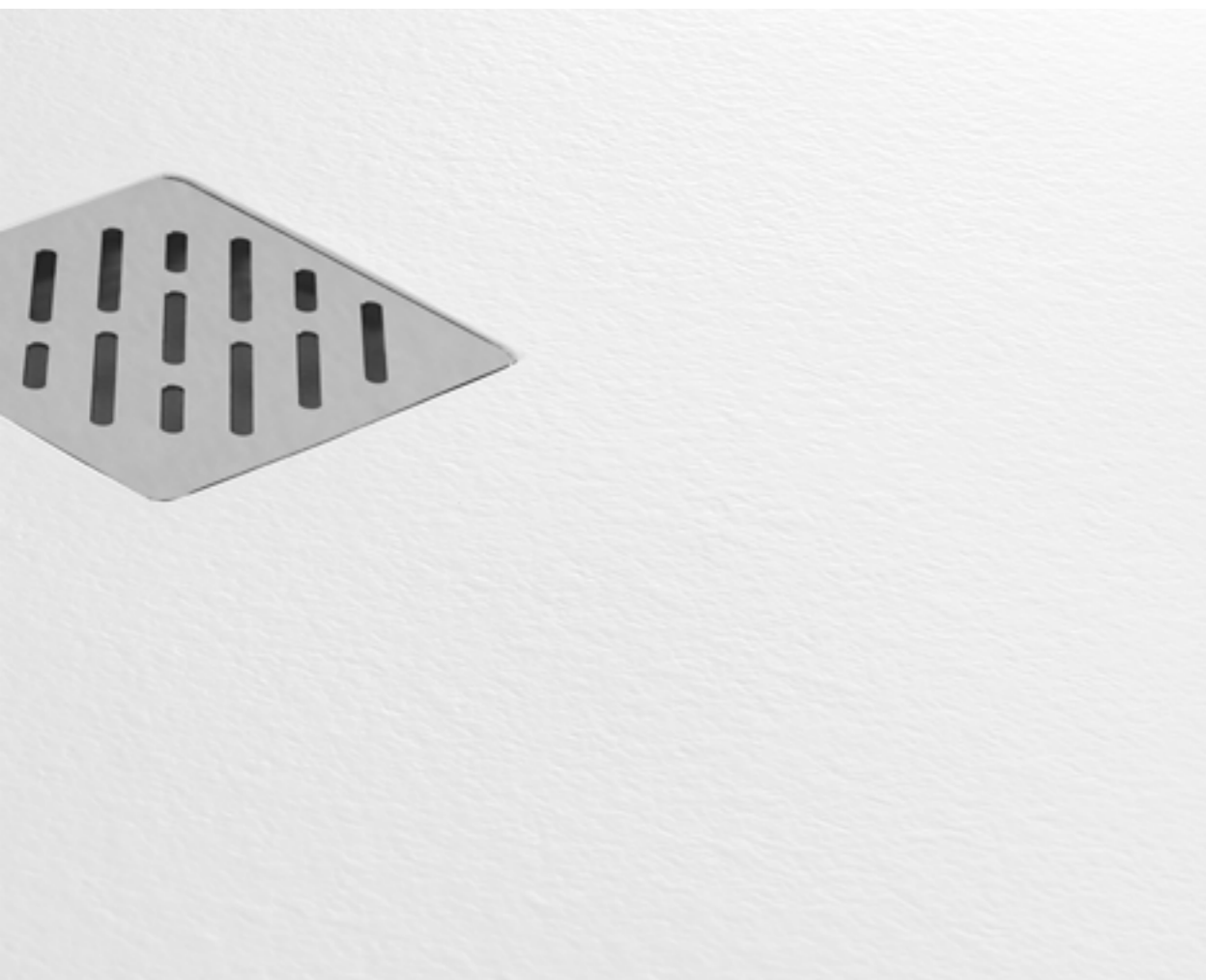

GRIGLIA

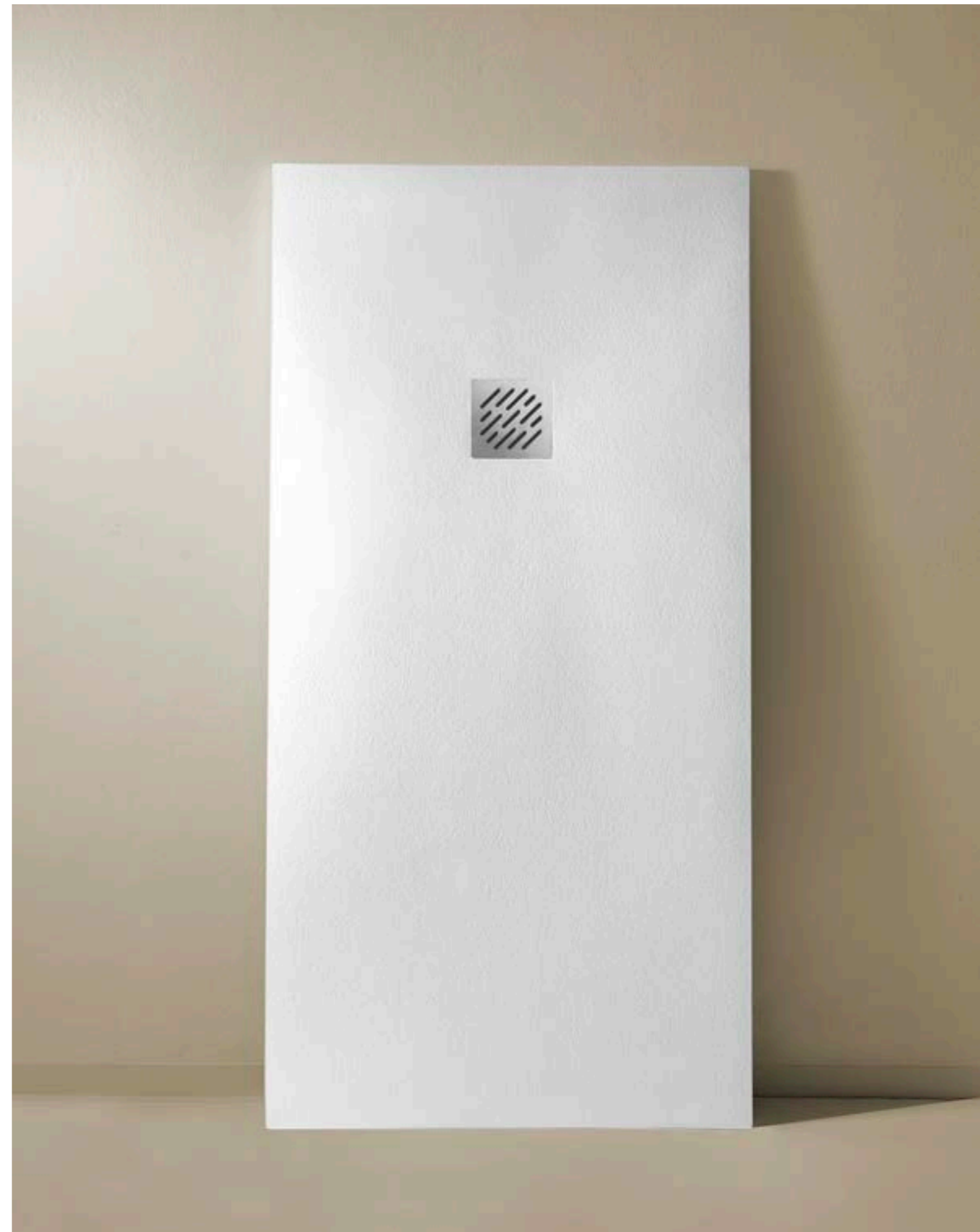
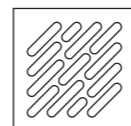

Arno Sezione Tecnica

Dimensioni (cm)

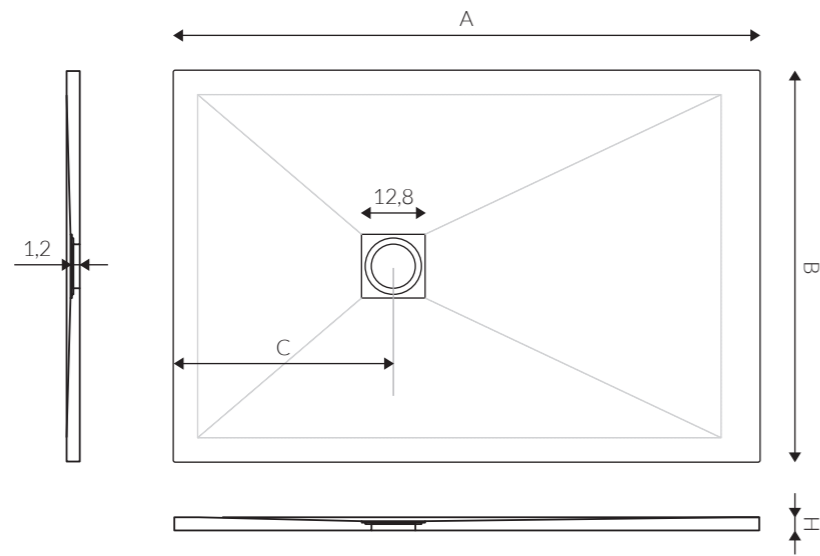

B 70			B 80			B 90			B 100		
A	C	H	A	C	H	A	C	H	A	C	H
80	35	2,2	80	35	2,2	-	-	-	-	-	-
90	35	2,2	90	35	2,2	90	35	2,2	-	-	-
100	35	2,2	100	35	2,2	100	44	2,2	100	44	2,2
110	44	2,2	110	44	2,2	110	44	2,2	110	44	2,2
120	44	2,2	120	44	2,2	120	44	2,2	120	44	2,2
130	44	2,4	130	44	2,4	130	35	2,4	130	35	2,4
140	44	2,4	140	44	2,4	140	35	2,4	140	35	2,4
150	44	2,5	150	44	2,5	150	44	2,5	150	50	2,5
160	44	2,6	160	44	2,6	160	50	2,6	160	50	2,6
170	44	2,6	170	44	2,6	170	50	2,6	170	50	2,6
180	44	2,6	180	44	2,6	180	44	2,6	180	50	2,6
190	50	2,6	190	50	2,6	190	50	2,6	190	50	2,6
200	50	2,8	200	50	2,8	200	50	2,8	200	50	2,8

Griglia

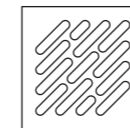

Misura	INOX	STANDARD	RAL / NCS
12,8x12,8 cm	✓	✓	✓

Scarichi (mm)

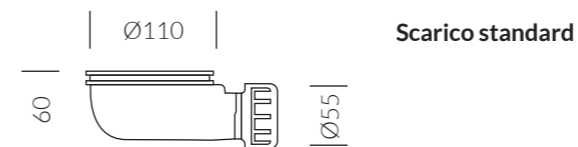

Tagli su misura

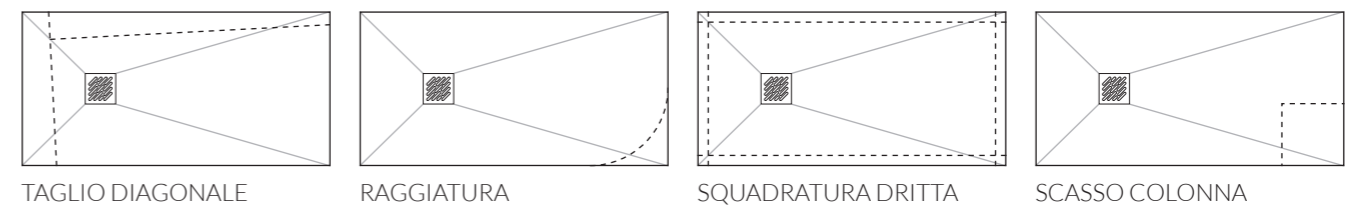

Bordi

Spessore bordo 4 cm

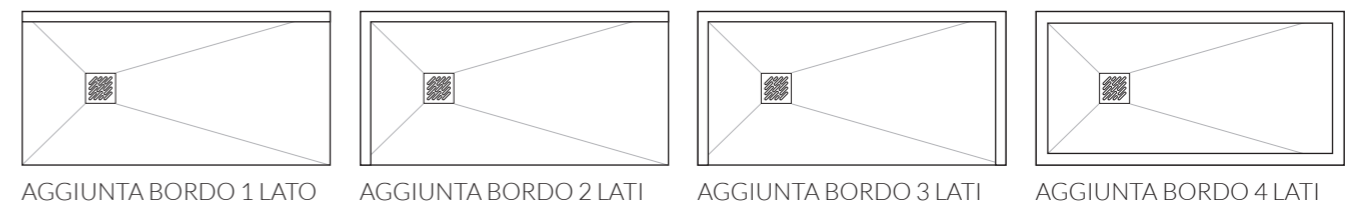

Zoccoli per piatti a gradino

Spessore su misura

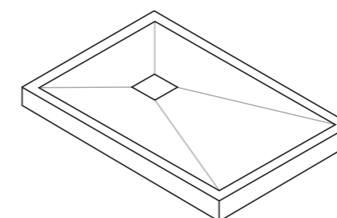

Classe antiscivolo

Normativa DIN 51097: A+B

Note

Le immagini sono da intendersi a scopo illustrativo e non costituiscono vincolo contrattuale. In caso di installazione di box doccia walk-in, con almeno un lato aperto, è consigliata l'aggiunta di un bordo per limitare la fuoriuscita d'acqua. Maggiori informazioni sono disponibili nella sezione "Bordi".

Tevere cemento

TEXTURE



CEMENTO

COLORI STANDARD



ANTRACITE
RAL 7043



URBAN
RAL 7006



TORTORA
RAL 1019



SABBIA
RAL 1013



GRIGIO
RAL 7047



BIANCO
RAL 9003

COLORI CUSTOM



RAL / NCS



Tevere cemento

Superficie antiscivolo effetto CEMENTO (opaco).



Scarico in posizione centrale.

Piletta standard diametro 9 cm.

Disponibile in una gamma di misure molto ampia per garantire la massima adattabilità.

Può essere tagliato su 4 lati.

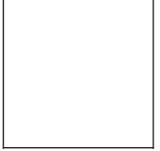
MISURE STANDARD

70 x	80 x	90 x	100 x
			
80	80	90	100
90	90	100	110
100	100	110	120
110	110	120	130
120	120	130	140
130	130	140	150
140	140	150	160
150	150	160	170
160	160	170	180
170	170	180	190
180	180	190	200
190	190	200	
200	200		

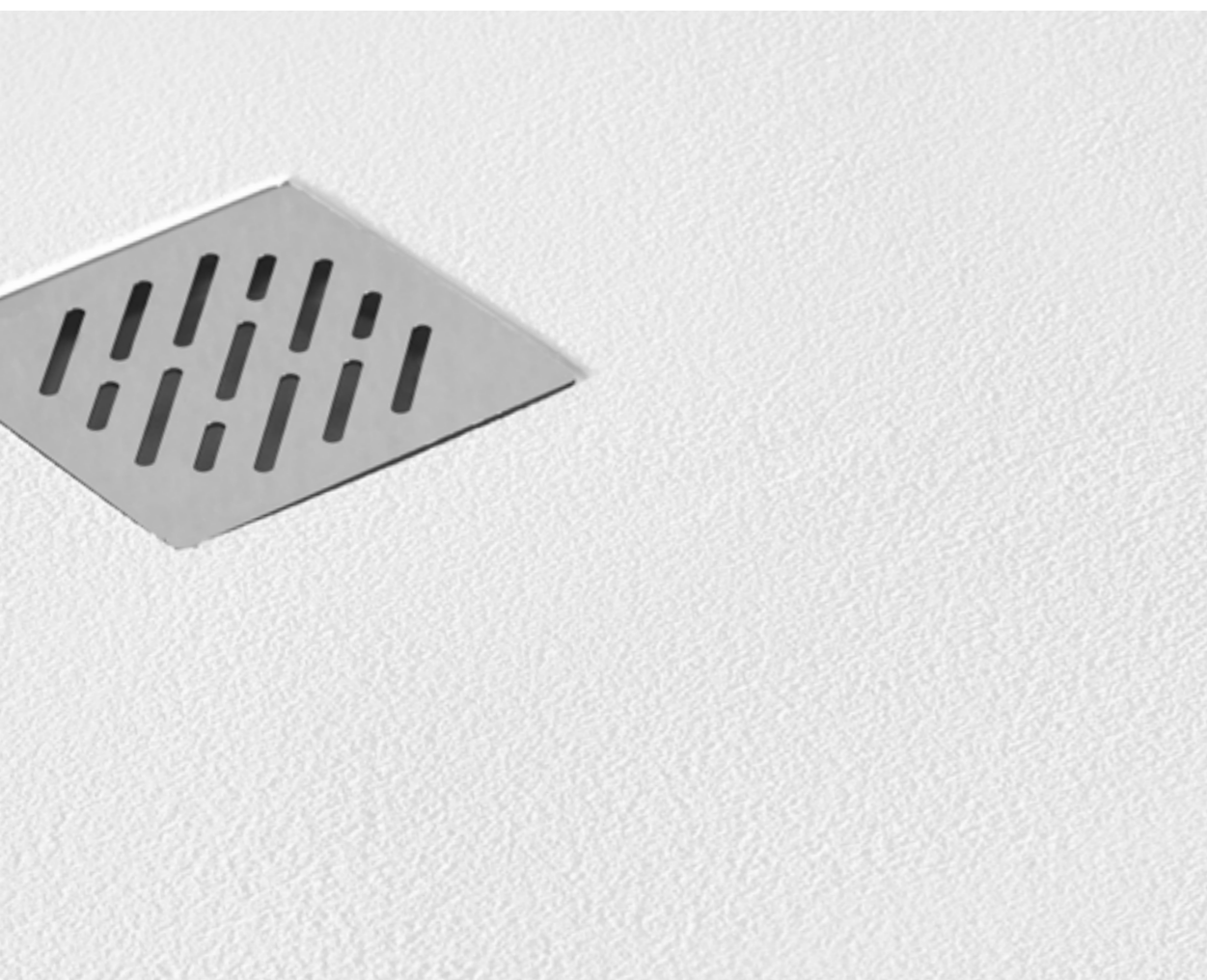

GRIGLIA

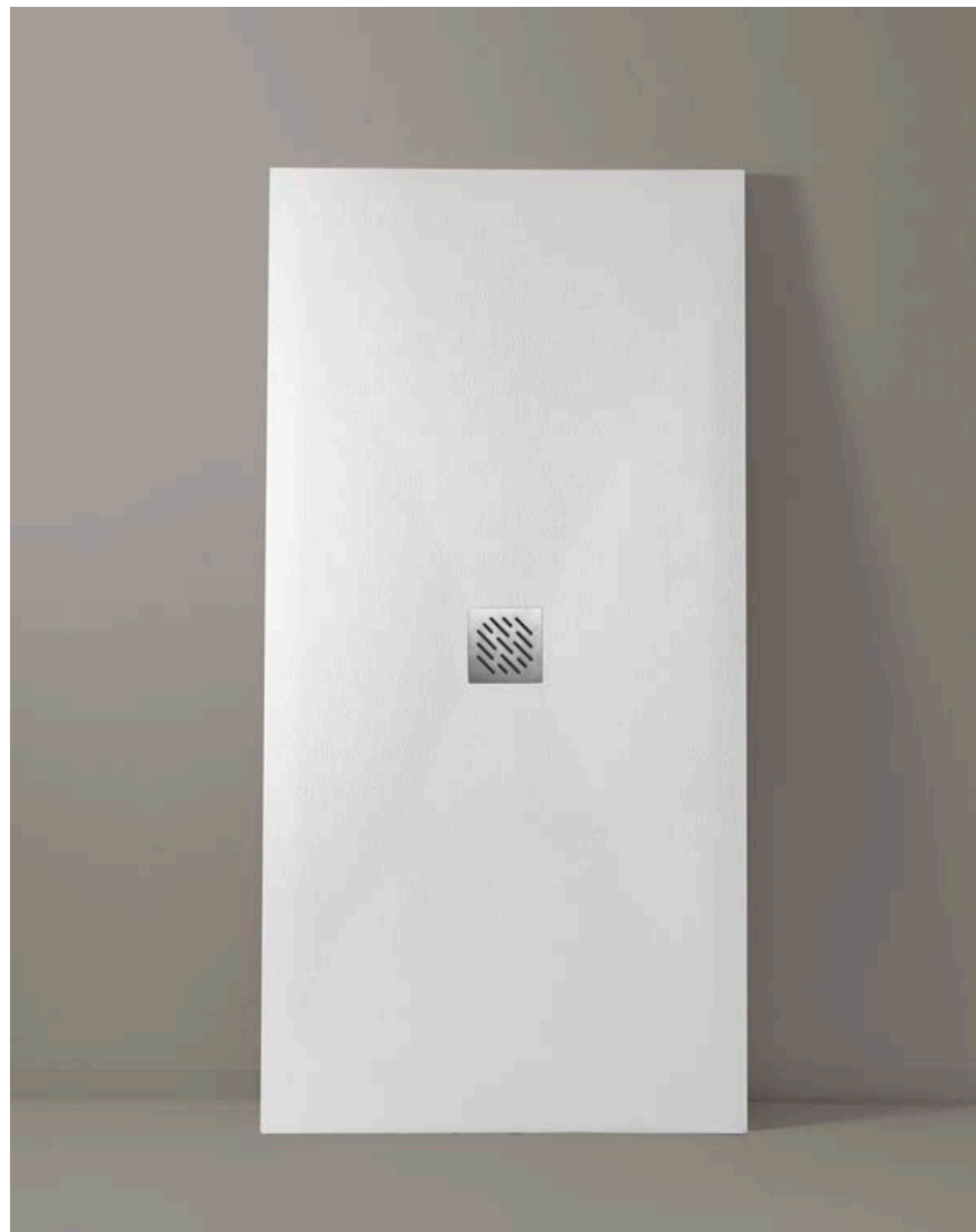
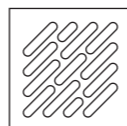

Tevere Cemento Sezione Tecnica

Dimensioni (cm)

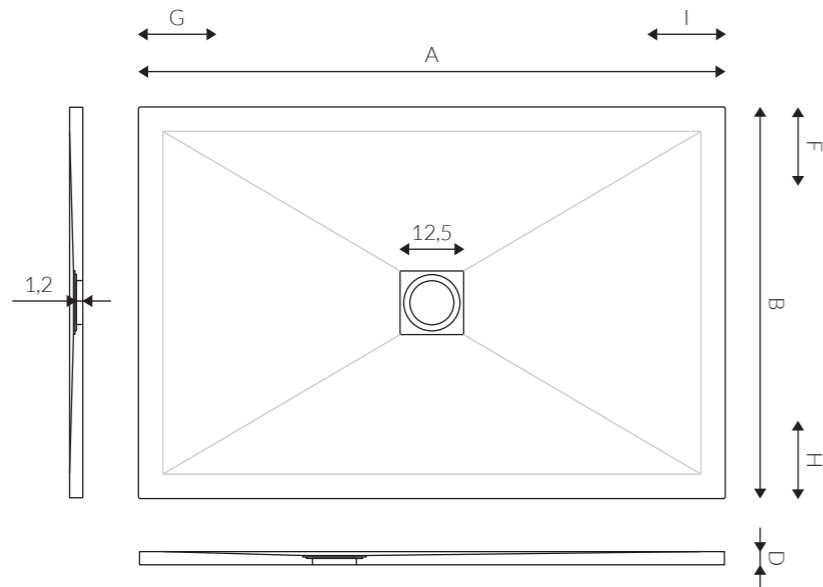

B 70						B 80					
A	D	G	I	F	H	A	D	G	I	F	H
80	2,5	5	5	3	3	80	2,5	5	5	4,5	4,5
90	2,5	5	5	3	3	90	2,5	5	5	4,5	4,5
100	2,5	5	5	3	3	100	2,5	5	5	4,5	4,5
110	2,5	5	5	3	3	110	2,5	5	5	4,5	4,5
120	2,5	5	5	3	3	120	2,5	5	5	4,5	4,5
130	2,7	5	5	3	3	130	2,7	5	5	4,5	4,5
140	2,7	5	5	3	3	140	2,7	5	5	4,5	4,5
150	2,7	5	5	3	3	150	2,7	5	5	4,5	4,5
160	3,0	5	5	3	3	160	3,0	5	5	4,5	4,5
170	3,0	5	5	3	3	170	3,0	5	5	4,5	4,5
180	3,0	5	5	3	3	180	3,0	5	5	4,5	4,5
190	3,2	5	5	3	3	190	3,2	5	5	4,5	4,5
200	3,2	5	5	3	3	200	3,2	5	5	4,5	4,5

B 90						B 100					
A	D	G	I	F	H	A	D	G	I	F	H
90	2,5	5	5	4,5	4,5	-	-	5	5	4,5	4,5
100	2,5	5	5	4,5	4,5	100	2,5	5	5	4,5	4,5
110	2,5	5	5	4,5	4,5	-	-	5	5	4,5	4,5
120	2,5	5	5	4,5	4,5	120	2,5	5	5	4,5	4,5
130	2,7	5	5	4,5	4,5	-	-	5	5	4,5	4,5
140	2,7	5	5	4,5	4,5	140	2,7	5	5	4,5	4,5
150	2,7	5	5	4,5	4,5	150	2,9	5	5	4,5	4,5
160	3,0	5	5	4,5	4,5	160	2,9	5	5	4,5	4,5
170	3,0	5	5	4,5	4,5	-	-	5	5	4,5	4,5
180	3,0	5	5	4,5	4,5	180	3,0	5	5	4,5	4,5
190	3,2	5	5	4,5	4,5	-	-	5	5	4,5	4,5
200	3,2	5	5	4,5	4,5	200	3,2	5	5	4,5	4,5

Griglia

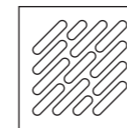

Misura	INOX	STANDARD	RAL / NCS
12,5 x 12,5 cm	✓	✓	✓

Scarichi (mm)



Tagli su misura

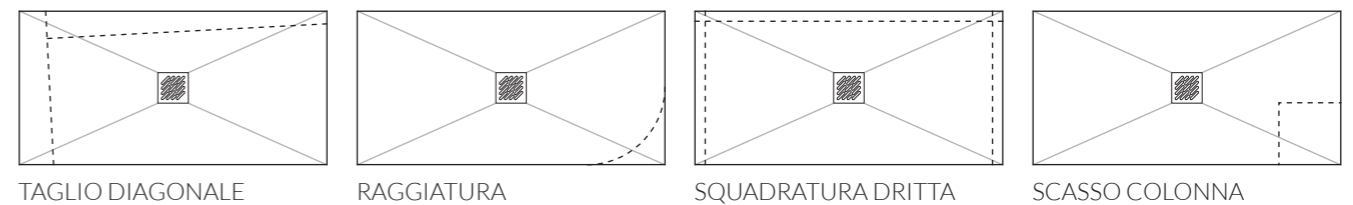

Bordi

Spessore bordo 4 cm

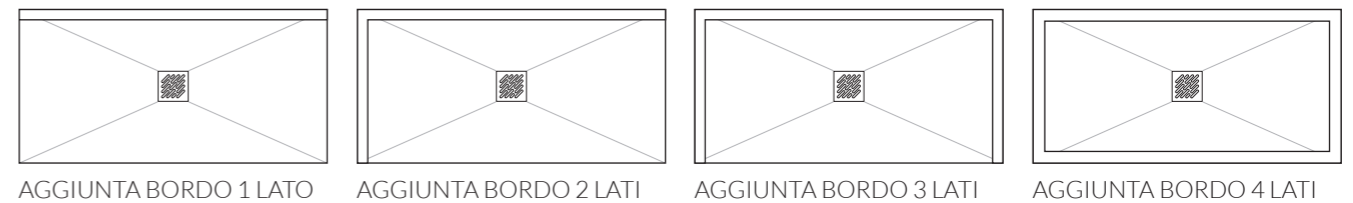

Zoccoli per piatti a gradino

Spessore su misura

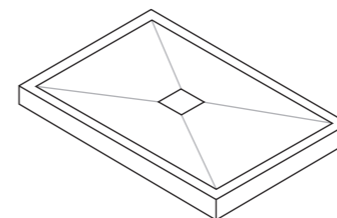

Classe antiscivolo

Normativa DIN 51097: A+B

Note

Le immagini sono da intendersi a scopo illustrativo e non costituiscono vincolo contrattuale. In caso di installazione di box doccia walk-in, con almeno un lato aperto, è consigliata l'aggiunta di un bordo per limitare la fuoriuscita d'acqua. Maggiori informazioni sono disponibili nella sezione "Bordi".

Tevere soft

TEXTURE



SOFT (opaco)

COLORI STANDARD



ANTRACITE
RAL 7043



URBAN
RAL 7006



TORTORA
RAL 1019



SABBIA
RAL 1013



GRIGIO
RAL 7047



BIANCO
RAL 9003

COLORI CUSTOM



RAL / NCS



Tevere soft

Superficie antiscivolo effetto SOFT (opaco).



Scarico in posizione centrale.

Piletta standard diametro 9 cm.

Disponibile in una gamma di misure molto ampia per garantire la massima adattabilità.

Può essere tagliato su 4 lati.

MISURE STANDARD

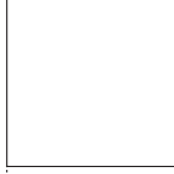
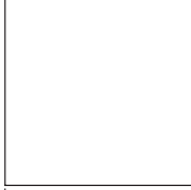
70 x	80 x	90 x	100 x
			
80	80	90	100
90	90	100	110
100	100	110	120
110	110	120	130
120	120	130	140
130	130	140	150
140	140	150	160
150	150	160	170
160	160	170	180
170	170	180	190
180	180	190	200
190	190	200	
200	200		



GRIGLIA

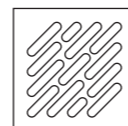

Tevere Soft Sezione Tecnica

Dimensioni (cm)

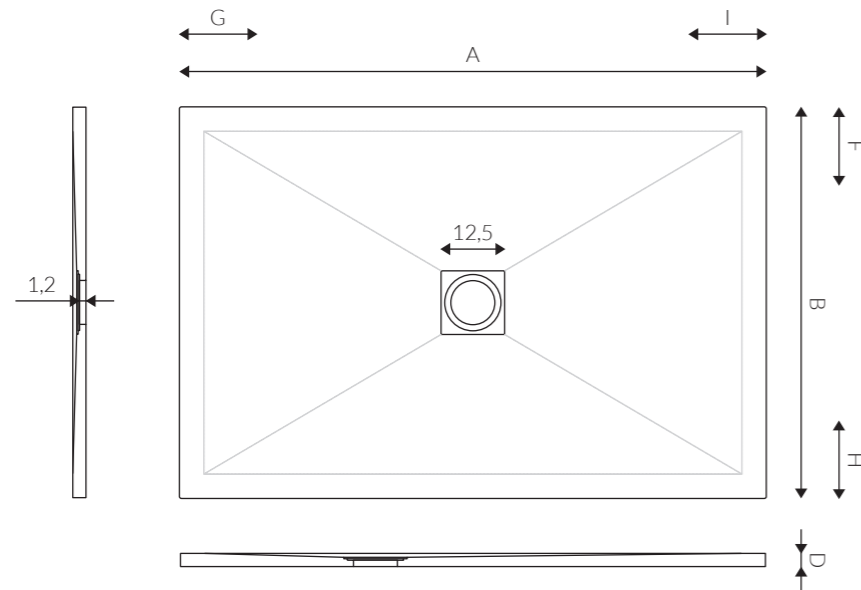

B 70						B 80					
A	D	G	I	F	H	A	D	G	I	F	H
80	2,5	5	5	3	3	80	2,5	5	5	4,5	4,5
90	2,5	5	5	3	3	90	2,5	5	5	4,5	4,5
100	2,5	5	5	3	3	100	2,5	5	5	4,5	4,5
110	2,5	5	5	3	3	110	2,5	5	5	4,5	4,5
120	2,5	5	5	3	3	120	2,5	5	5	4,5	4,5
130	2,7	5	5	3	3	130	2,7	5	5	4,5	4,5
140	2,7	5	5	3	3	140	2,7	5	5	4,5	4,5
150	2,7	5	5	3	3	150	2,7	5	5	4,5	4,5
160	3,0	5	5	3	3	160	3,0	5	5	4,5	4,5
170	3,0	5	5	3	3	170	3,0	5	5	4,5	4,5
180	3,0	5	5	3	3	180	3,0	5	5	4,5	4,5
190	3,2	5	5	3	3	190	3,2	5	5	4,5	4,5
200	3,2	5	5	3	3	200	3,2	5	5	4,5	4,5

B 90						B 100					
A	D	G	I	F	H	A	D	G	I	F	H
90	2,5	5	5	4,5	4,5	-	-	5	5	4,5	4,5
100	2,5	5	5	4,5	4,5	100	2,5	5	5	4,5	4,5
110	2,5	5	5	4,5	4,5	-	-	5	5	4,5	4,5
120	2,5	5	5	4,5	4,5	120	2,5	5	5	4,5	4,5
130	2,7	5	5	4,5	4,5	-	-	5	5	4,5	4,5
140	2,7	5	5	4,5	4,5	140	2,7	5	5	4,5	4,5
150	2,7	5	5	4,5	4,5	150	2,9	5	5	4,5	4,5
160	3,0	5	5	4,5	4,5	160	2,9	5	5	4,5	4,5
170	3,0	5	5	4,5	4,5	-	-	5	5	4,5	4,5
180	3,0	5	5	4,5	4,5	180	3,0	5	5	4,5	4,5
190	3,2	5	5	4,5	4,5	-	-	5	5	4,5	4,5
200	3,2	5	5	4,5	4,5	200	3,2	5	5	4,5	4,5

Griglia

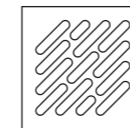

Misura	INOX	STANDARD	RAL / NCS
12,5 x 12,5 cm	✓	✓	✓

Scarichi (mm)

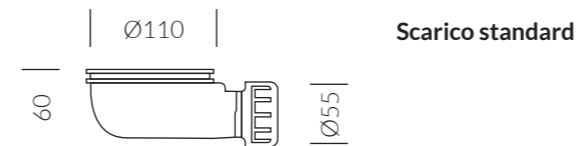

Tagli su misura

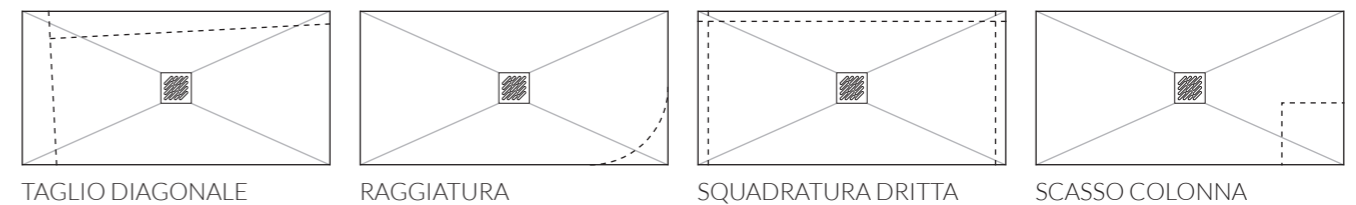

Bordi

Spessore bordo 4 cm

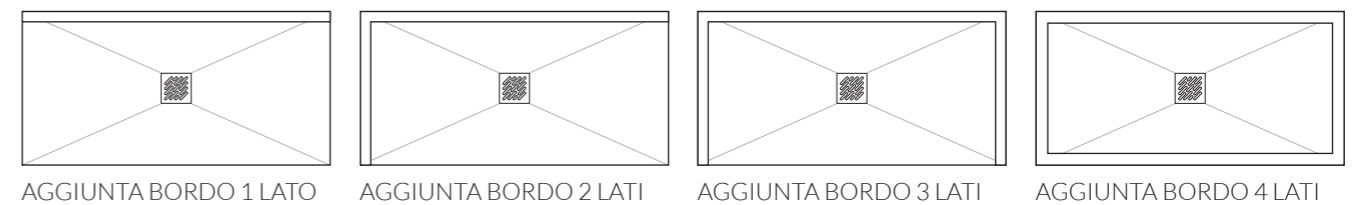

Zoccoli per piatti a gradino

Spessore su misura

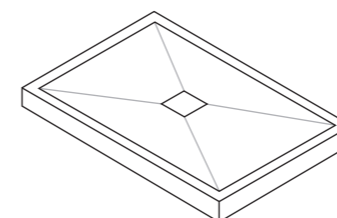

Classe antiscivolo

Normativa DIN 51097: A

Note

Le immagini sono da intendersi a scopo illustrativo e non costituiscono vincolo contrattuale. In caso di installazione di box doccia walk-in, con almeno un lato aperto, è consigliata l'aggiunta di un bordo per limitare la fuoriuscita d'acqua. Maggiori informazioni sono disponibili nella sezione "Bordi".

Reno

TEXTURE



PIETRA

COLORI STANDARD



ANTRACITE
RAL 7043



URBAN
RAL 7006



TORTORA
RAL 1019



SABBIA
RAL 1013



GRIGIO
RAL 7047



BIANCO
RAL 9003

COLORI CUSTOM



RAL / NCS



Reno

Superficie effetto PIETRA.
Scarico in posizione centrale.
Piletta standard diametro 9 cm.

MISURE STANDARD

90 x 70 SX

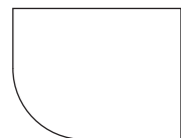

90 x 70 DX

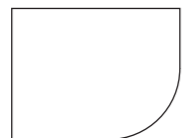

80 x 80

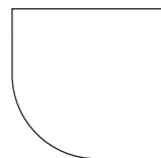

90 x 90

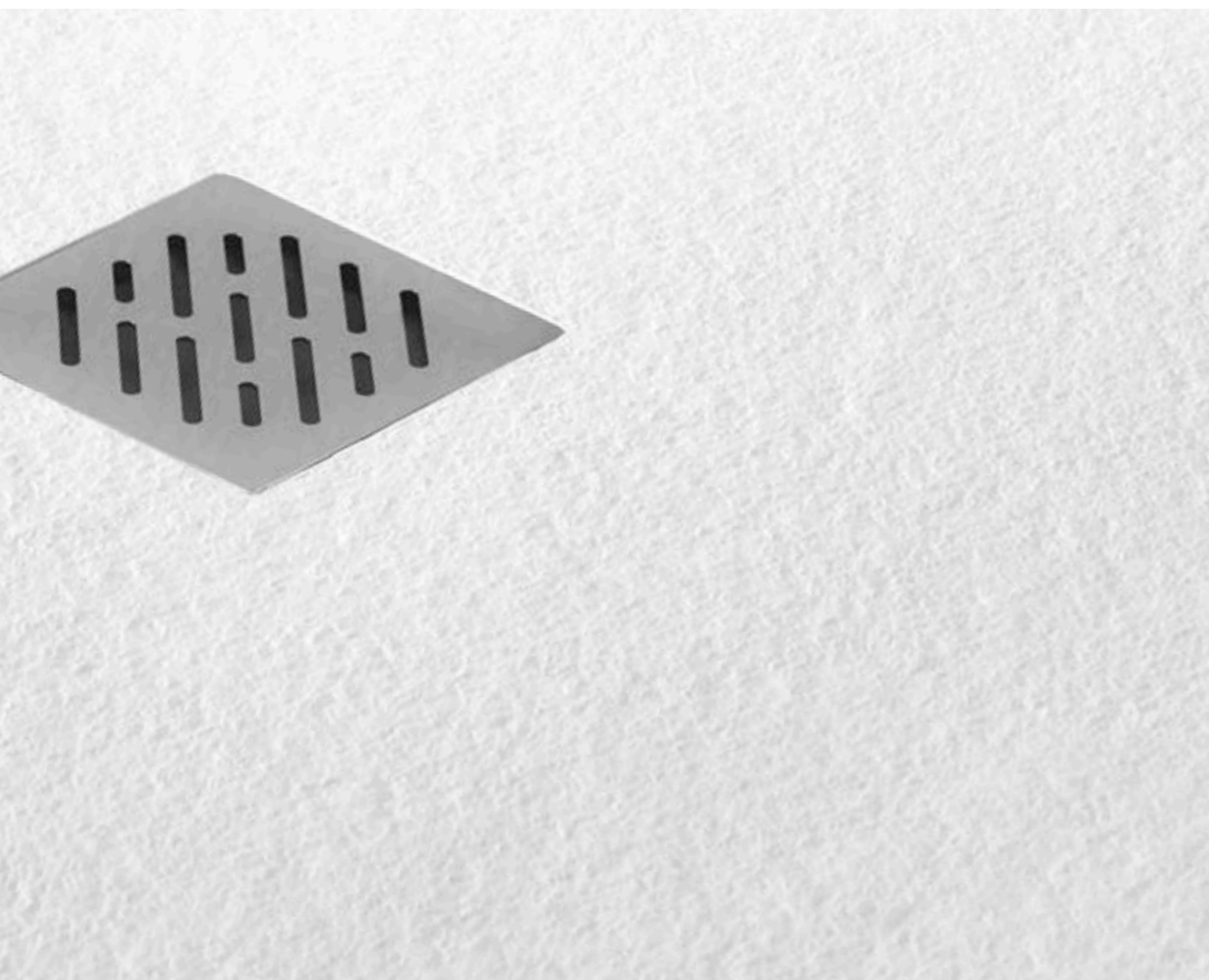
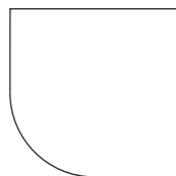

GRIGLIA

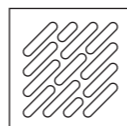

Reno Sezione Tecnica

Dimensioni (cm)

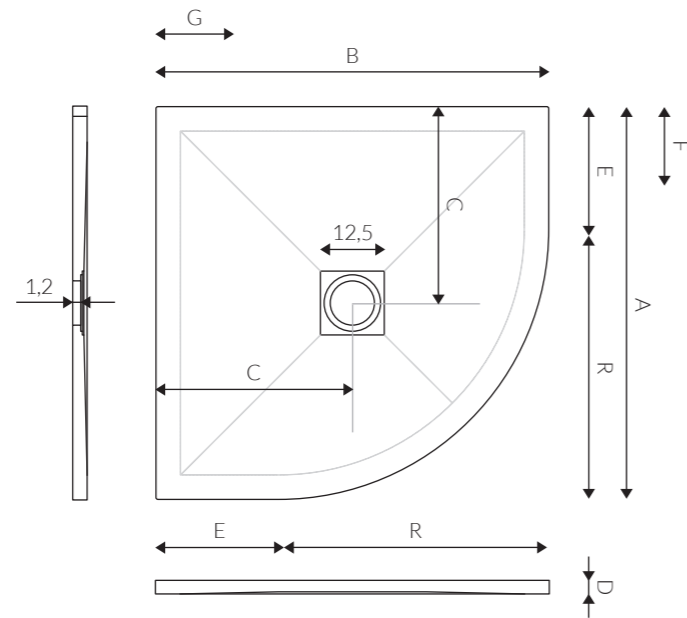

B 70						
A	C	D	E	F	G	R (DX - SX)
90	35/45	2,5	52/32	5	5	38

B 80						
A	C	D	E	F	G	R
80	40	2,5	25	5	5	55

B 90						
A	C	D	E	F	G	R
90	45	2,7	35	5	5	55

Griglia

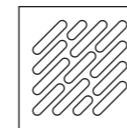

Misura	INOX	STANDARD	RAL / NCS
12,5 x 12,5 cm	✓	✓	✓

Scarichi (mm)

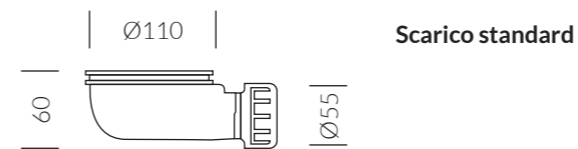

Tagli su misura

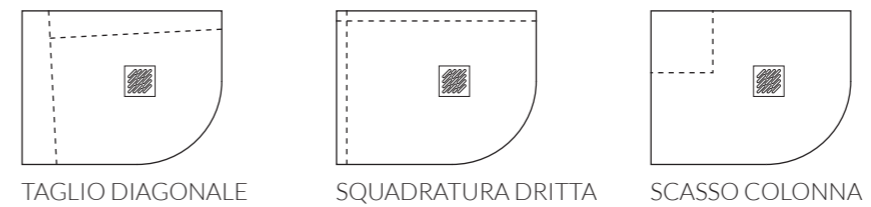

LA RAGGIATURA È FISSA

Bordi - NON possono essere aggiunti bordi

Zoccoli per piatti a gradino - NON possono essere applicati

Classe antiscivolo

Normativa DIN 51097: A+B+C

Note

Le immagini sono da intendersi a scopo illustrativo e non costituiscono vincolo contrattuale. In caso di installazione di box doccia walk-in, con almeno un lato aperto, è consigliata l'aggiunta di un bordo per limitare la fuoriuscita d'acqua. Maggiori informazioni sono disponibili nella sezione "Bordi".

Bordi



Il bordo aggiuntivo è un profilo perimetrale che viene integrato sul piatto doccia per offrire maggiore sicurezza durante l'utilizzo, riducendo il rischio di fuoriuscite d'acqua. La sua presenza garantisce una protezione efficace, soprattutto nei punti non coperti dal box doccia.

In presenza di tagli speciali che coinvolgono anche la zona in pendenza del piatto, il bordo viene adattato su misura al profilo del taglio, mantenendo una perfetta aderenza e assicurando una barriera efficace contro la fuoriuscita dell'acqua.

La dimensione standard del bordo è 1 cm in altezza e 4 cm in larghezza, ma su richiesta è possibile realizzare soluzioni personalizzate secondo progetto.

Il bordo può essere applicato su uno o più lati del piatto (da 1 a 4), ed è disponibile in finitura bianca, in cinque colori standard oppure in qualsiasi tonalità della scala RAL, per garantire il massimo livello di personalizzazione estetica.

Sezione piatto doccia

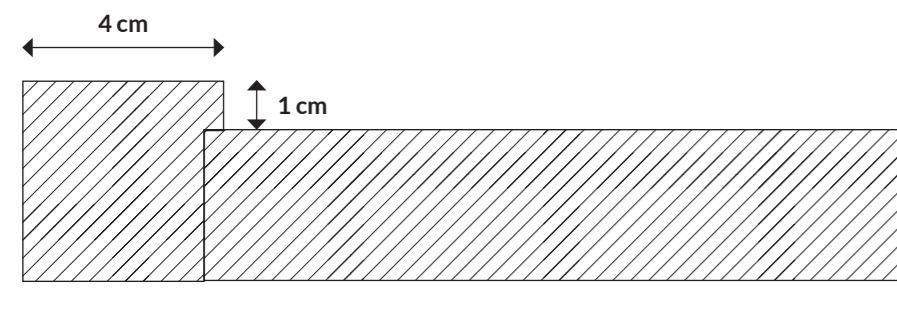

Aggiunta bordi

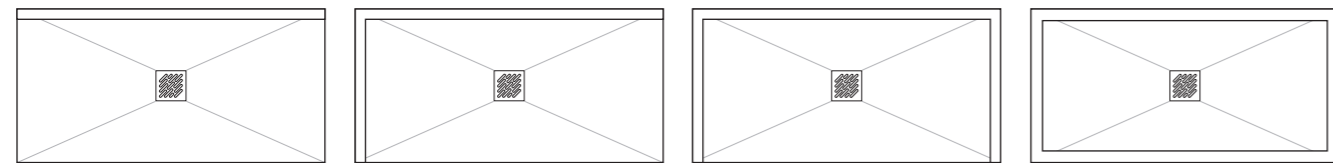

AGGIUNTA BORDO 1 LATO

AGGIUNTA BORDO 2 LATI

AGGIUNTA BORDO 3 LATI

AGGIUNTA BORDO 4 LATI

Note

Per un miglior deflusso dell'acqua è consigliabile aggiungere il bordo sui lati non a muro, dove non è previsto il montaggio del box doccia.

Tagli



I piatti doccia Riverstone sono progettati per essere facilmente tagliati su misura, offrendo un'eccellente flessibilità in fase di progettazione e installazione. Questo consente al professionista di adattare il prodotto con precisione agli spazi disponibili, riducendo il rischio di errori e ottimizzando i tempi di posa.

È possibile richiedere il piatto già tagliato direttamente in fase produttiva, selezionando la tipologia di taglio tra quelle disponibili a catalogo. Di seguito, una panoramica del processo di lavorazione.

Come avviene il taglio in produzione:

1. Taglio con disco diamantato

Il taglio viene effettuato tramite disco diamantato, che assicura precisione e pulizia della linea di taglio attraverso macchine CNC.

2. Finitura dei bordi

Una volta tagliato, il bordo viene levigato accuratamente per ottenere una superficie liscia, priva di imperfezioni e nuovamente gelcoattata.

Tagli su misura

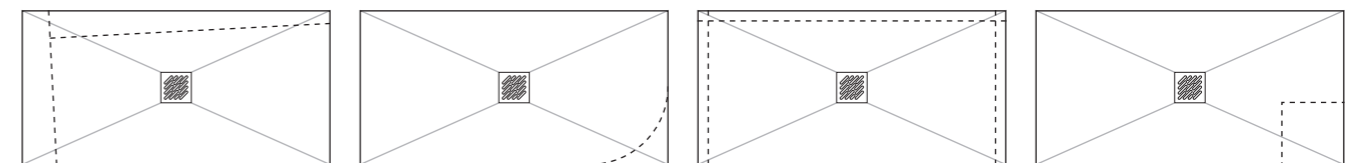

TAGLIO DIAGONALE

RAGGIATURA

SQUADRATURA DRITTA

SCASSO COLONNA

Accessori

Piletta scarico ribassata per piatti doccia

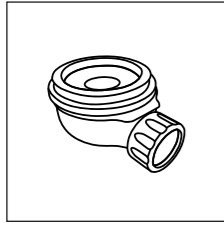

Piletta applicabile su:
ARNO
SENNA
TEVERE
RENO

Piletta scarico rettangolare per piatti doccia

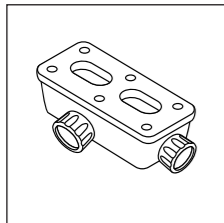

Piletta applicabile su:
TAMIGI
DANUBIO

Griglia

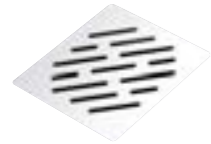
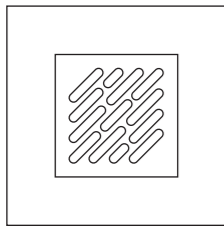

Griglia in acciaio inox, disponibile:
FINITURA LUCIDA (fronte retro)
VERNICIATURA COLORE (fronte retro)

INOX LUCIDO



AISI 316

COLORI STANDARD



ANTRACITE
RAL 7043



URBAN
RAL 7006



TORTORA
RAL 1019



SABBIA
RAL 1013



GRIGIO
RAL 7047



BIANCO
RAL 9003

COLORI CUSTOM



RAL / NCS



www.riverstone.it



Lavabi

62 Soft vasca singola

66 Soft vasca doppia

70 Cemento vasca singola

74 Cemento vasca doppia

78 Cover vasca singola

82 Cover vasca doppia

86 Thin 50

90 Thin 46

94 Smash

98 Egeo

102 Devon

106 Leg

110 Ellipse

114 Circle

118 Luka

122 Up & Down

126 Mensole

129 Accessori

Soft vasca singola

TEXTURE



COLORI STANDARD



COLORI CUSTOM



Soft vasca singola

Lavabo a consolle con vasca integrata.
Superficie liscia BIANCO (opaco/lucido) o COLORATO (opaco).
Disponibile nelle misure STANDARD o CUSTOM.

Dimensioni (cm)

MISURE STANDARD LAVABO

Vasca CENTRALE

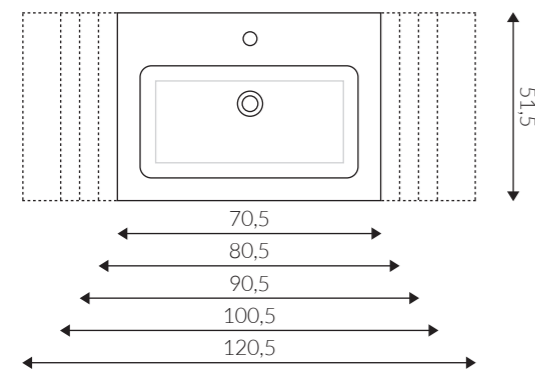

Vasca SX/DX

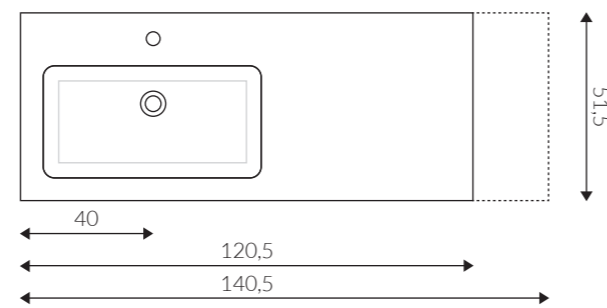

MISURE CUSTOM LAVABO

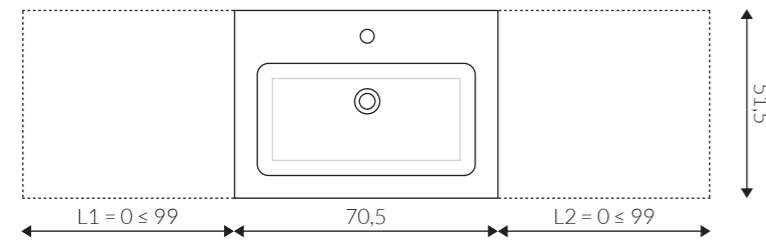

MISURE VASCA

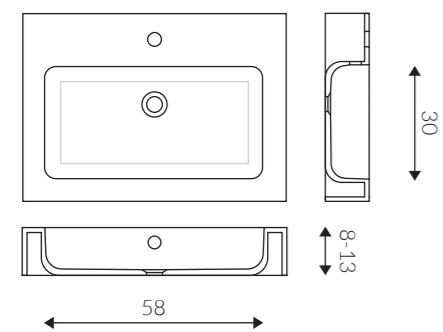

Accessori

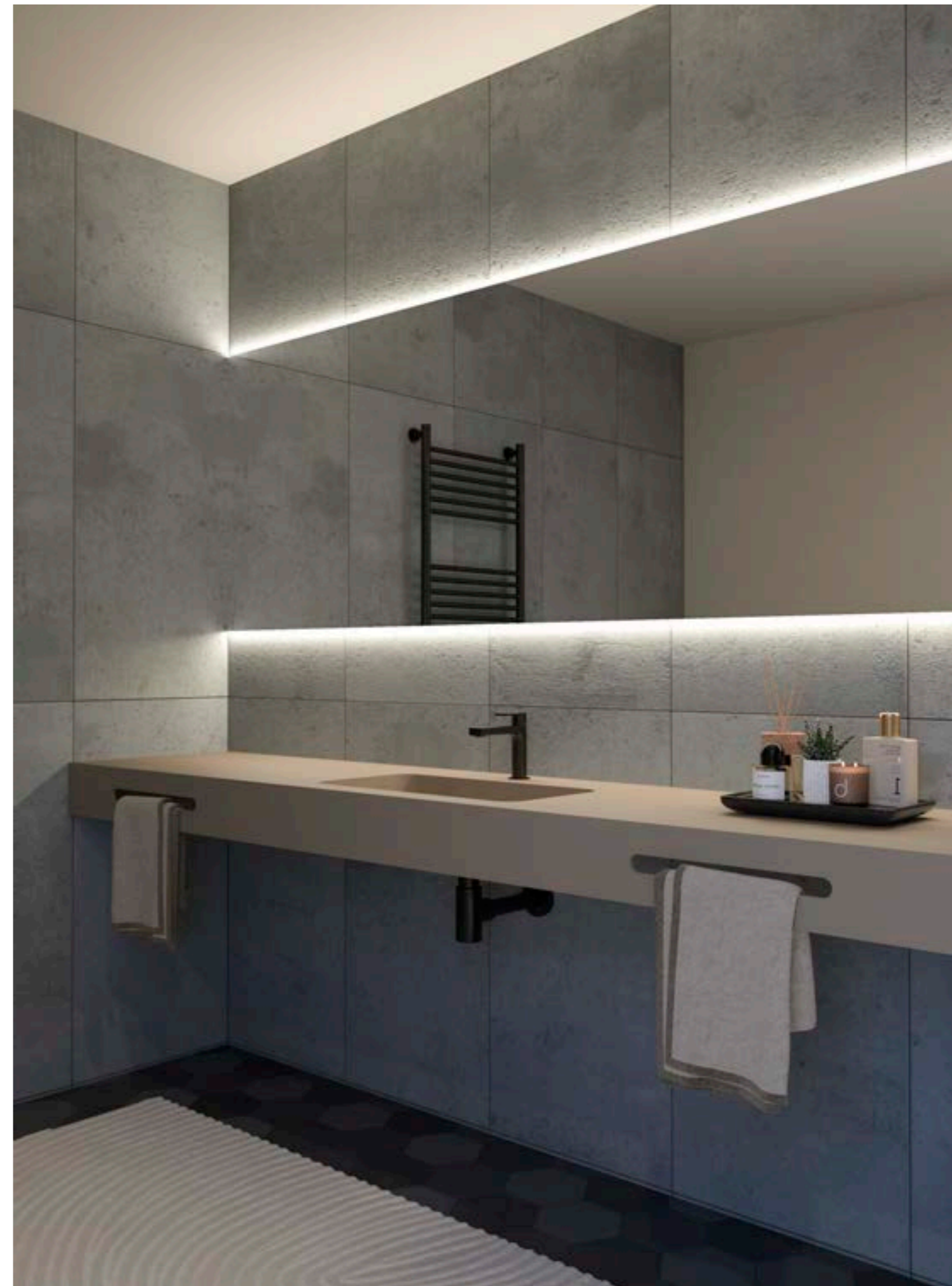

Soft vasca doppia

TEXTURE



COLORI STANDARD



COLORI CUSTOM



Soft vasca doppia

Lavabo a consolle con vasche integrate.
Superficie liscia BIANCO (opaco/lucido) o COLORATO (opaco).
Disponibile nelle misure STANDARD o CUSTOM.

Dimensioni (cm)

MISURE STANDARD LAVABO

Vasca 50x30

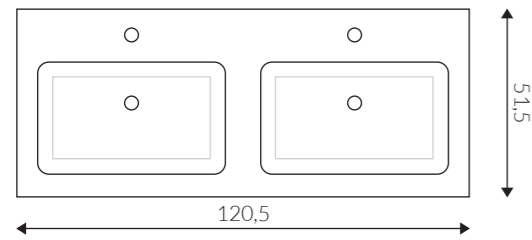

Vasca 58x30

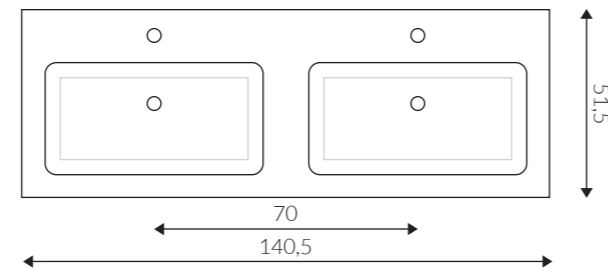

Vasca 58x30

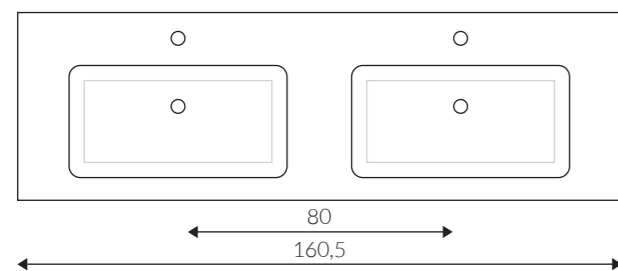

MISURE CUSTOM LAVABO

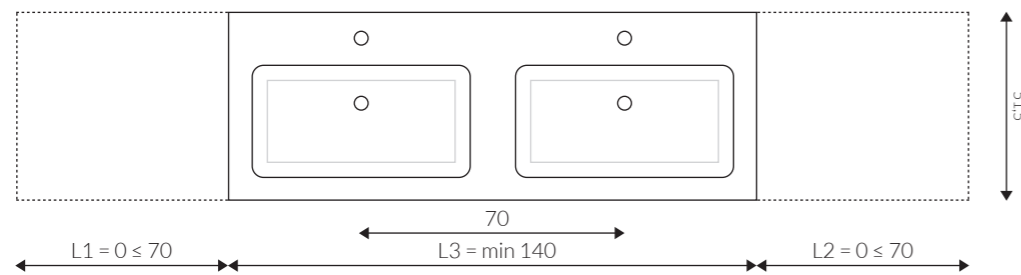

MISURE VASCA

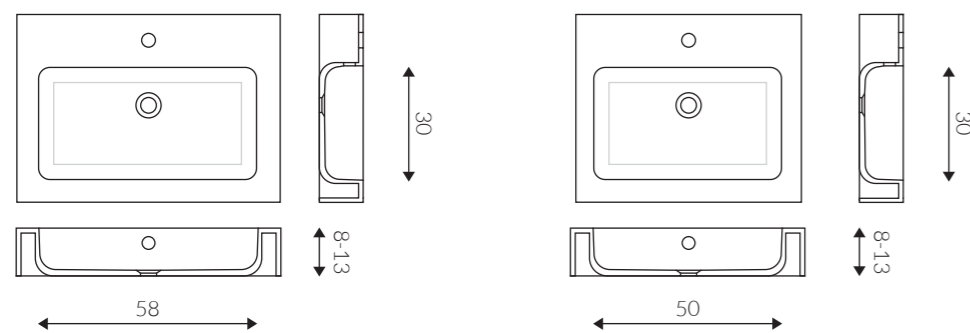

Accessori

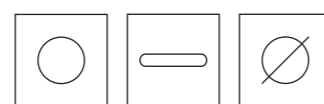

FORO TROPPOPIENO INCLUSO
A SCELTA TRA: ROTONDO,
FESSURA O SENZA FORO



Cemento vasca singola

TEXTURE



Esterno vasca:
CEMENTO



Interno vasca:
SOFT

COLORI STANDARD



ANTRACITE
RAL 7043



URBAN
RAL 7006



TORTORA
RAL 1019



SABBIA
RAL 1013



GRIGIO
RAL 7047



BIANCO
RAL 9003

COLORI CUSTOM



RAL / NCS



Cemento vasca singola

Lavabo a consolle con vasca integrata.
Superficie texture CEMENTO BIANCO (opaco) o COLORATO (opaco).
Disponibile nelle misure STANDARD o CUSTOM.

Dimensioni (cm)

MISURE STANDARD LAVABO

Vasca CENTRALE

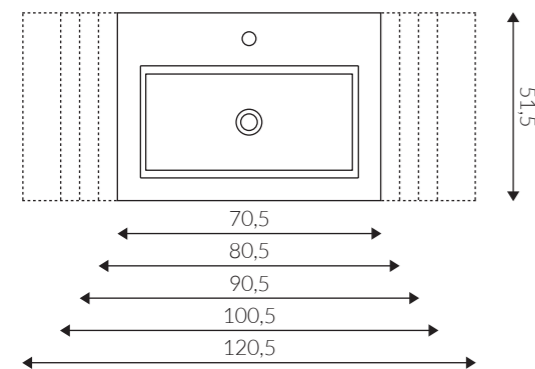

Vasca SX/DX

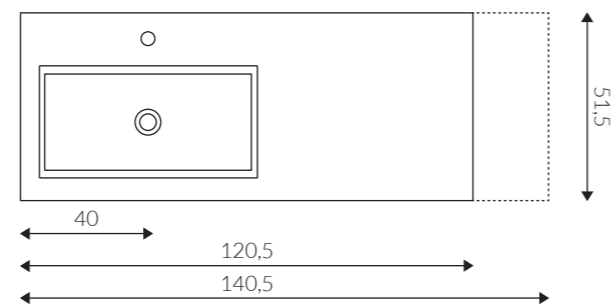

MISURE CUSTOM LAVABO

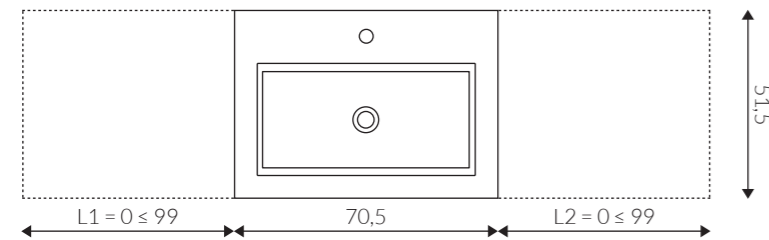

MISURE VASCA

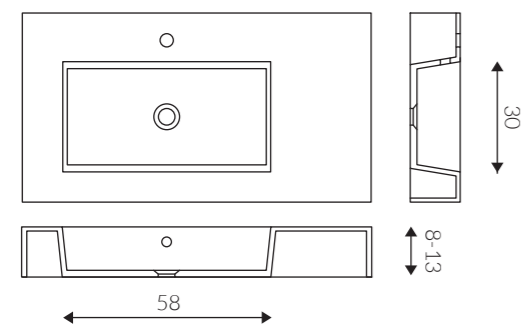

Accessori



Cemento vasca doppia

TEXTURE



Esterno vasca:
CEMENTO



Interno vasca:
SOFT

COLORI STANDARD



ANTRACITE
RAL 7043



URBAN
RAL 7006



TORTORA
RAL 1019



SABBIA
RAL 1013



GRIGIO
RAL 7047

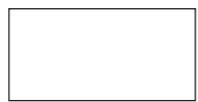

BIANCO
RAL 9003

COLORI CUSTOM



RAL / NCS



Cemento vasca doppia

Lavabo a consolle con vasche integrate.
Superficie texture CEMENTO BIANCO (opaco) o COLORATO (opaco).
Disponibile nelle misure STANDARD o CUSTOM.

Dimensioni (cm)

MISURE STANDARD LAVABO

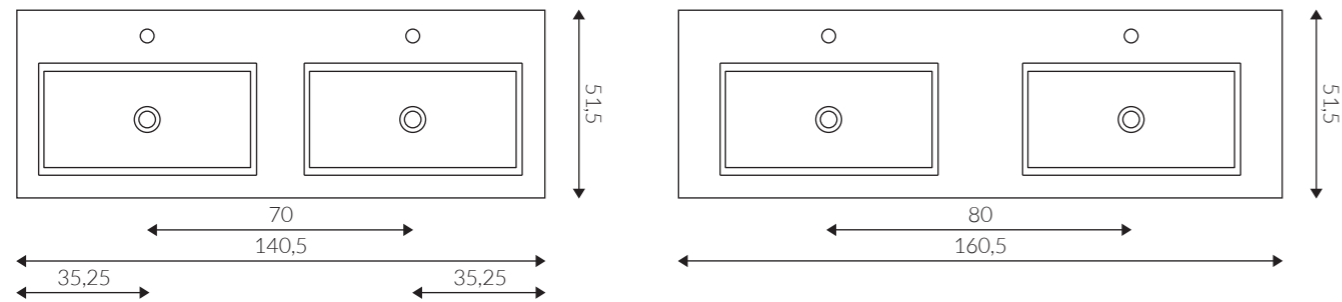

MISURE CUSTOM LAVABO

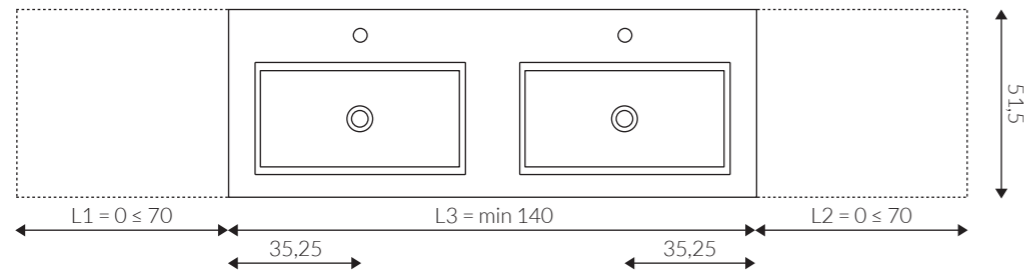

MISURE VASCA

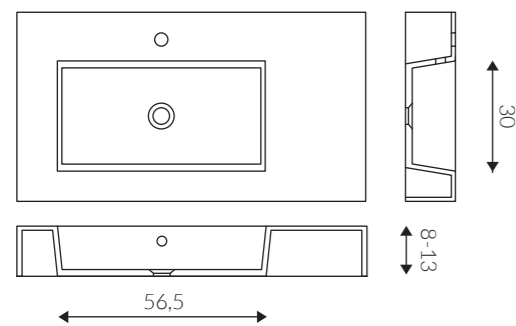

Accessori

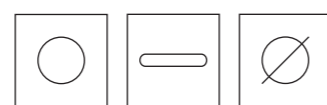

FORO TROPPOPIENO INCLUSO
A SCELTA TRA: ROTONDO,
FESSURA O SENZA FORO



Cover vasca singola

TEXTURE



SOFT

COLORI STANDARD



ANTRACITE
RAL 7043



URBAN
RAL 7006



TORTORA
RAL 1019



SABBIA
RAL 1013



GRIGIO
RAL 7047



BIANCO
RAL 9003

COLORI CUSTOM



RAL / NCS



Cover vasca singola

Lavabo a consolle con vasca integrata.
Superficie liscia BIANCO (opaco/lucido) o COLORATO (opaco).
Disponibile nelle misure STANDARD o CUSTOM.

Dimensioni (cm)

MISURE STANDARD LAVABO

Vasca CENTRALE

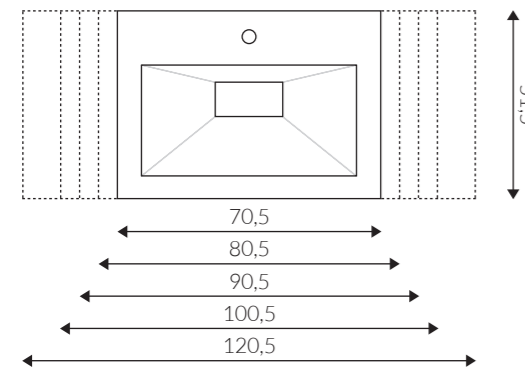

Vasca SX/DX

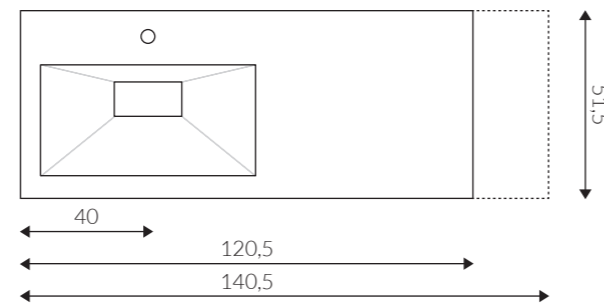

MISURE CUSTOM LAVABO

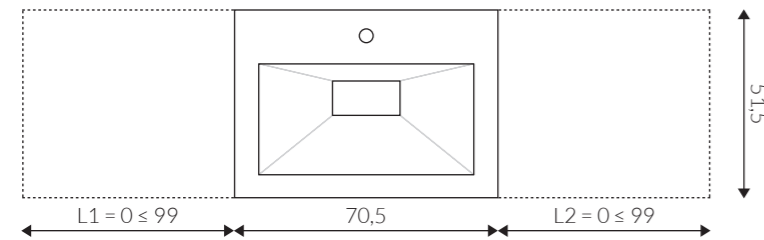

MISURE VASCA

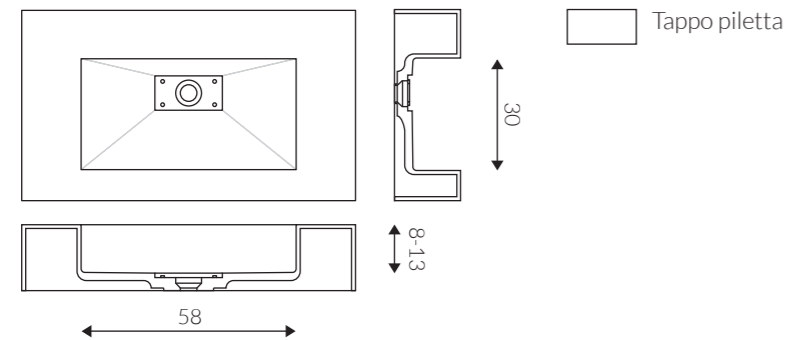

Accessori

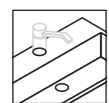

FORO RUBINETTO INCLUSO



KIT TROPPO PIENO INCLUSO

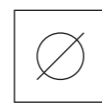
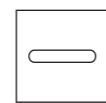
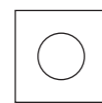

FORO TROPPOPIENO INCLUSO A SCELTA TRA: ROTONDO, FESSURA O SENZA FORO

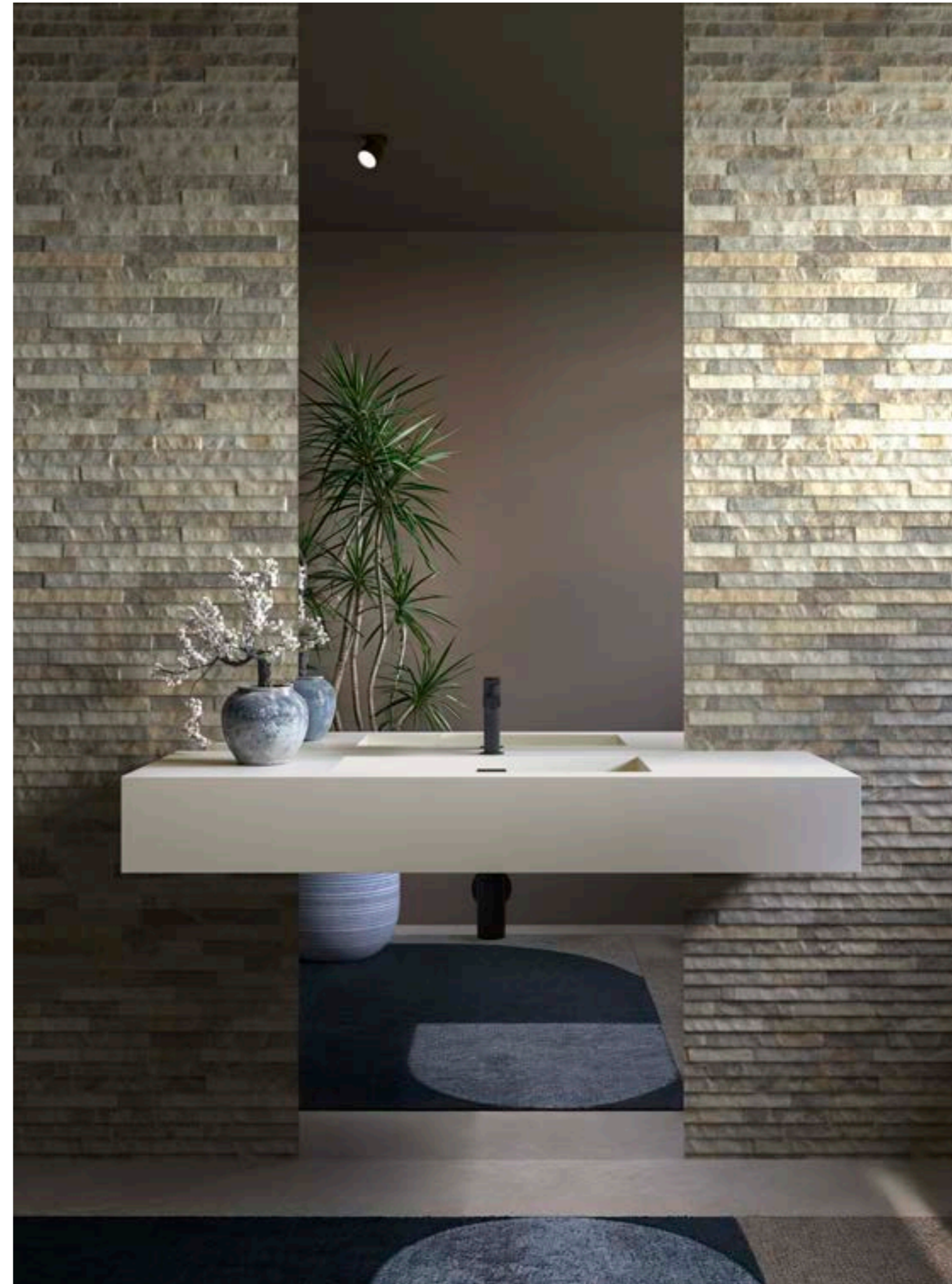

Cover vasca doppia

TEXTURE

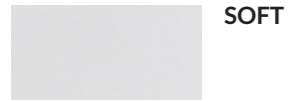

COLORI STANDARD



COLORI CUSTOM

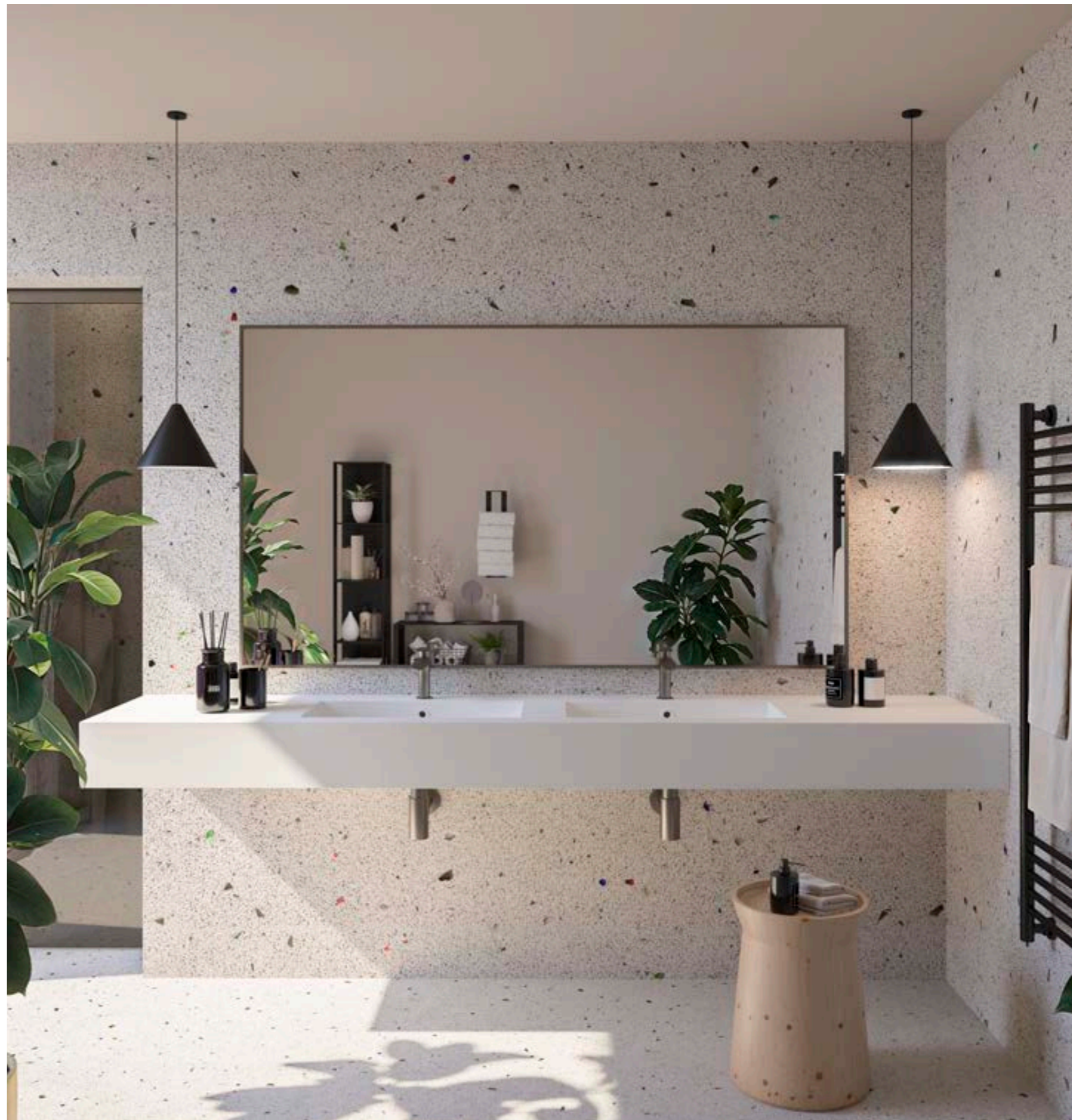
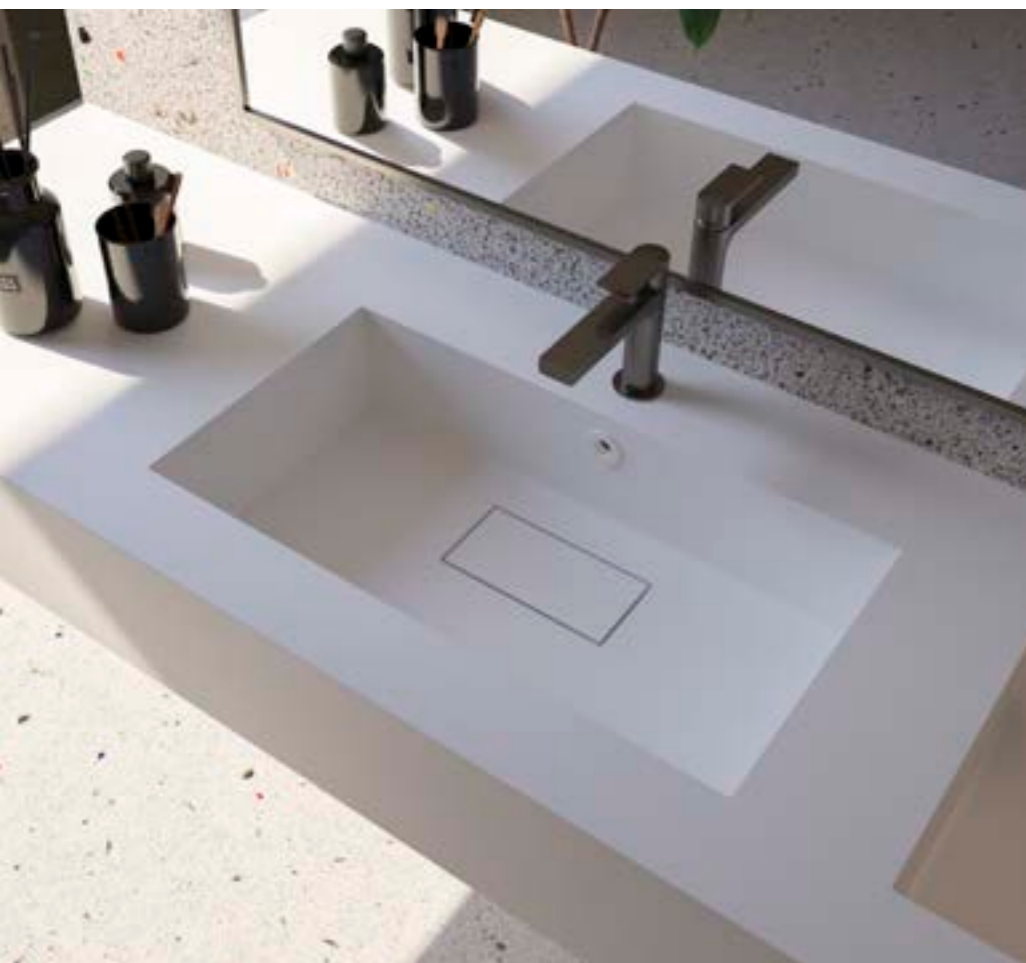

Cover vasca doppia

Lavabo a consolle con vasche integrate.
Superficie liscia BIANCO (opaco/lucido) o COLORATO (opaco).
Disponibile nelle misure STANDARD o CUSTOM.

Dimensioni (cm)

MISURE STANDARD LAVABO

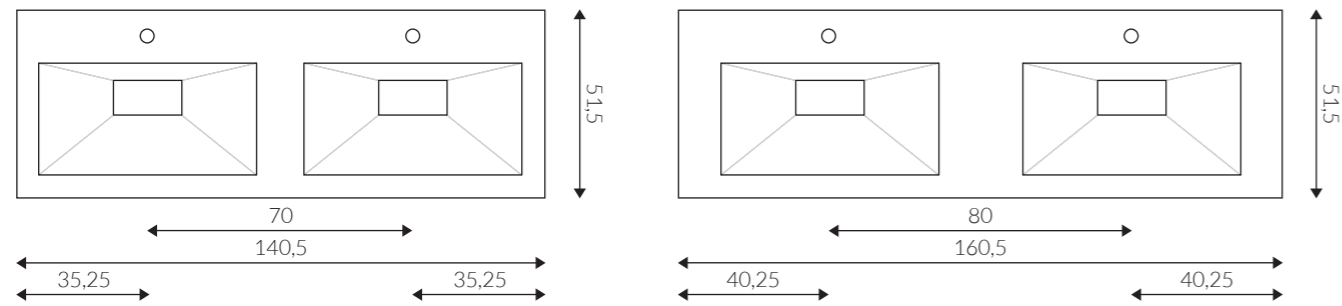

MISURE CUSTOM LAVABO

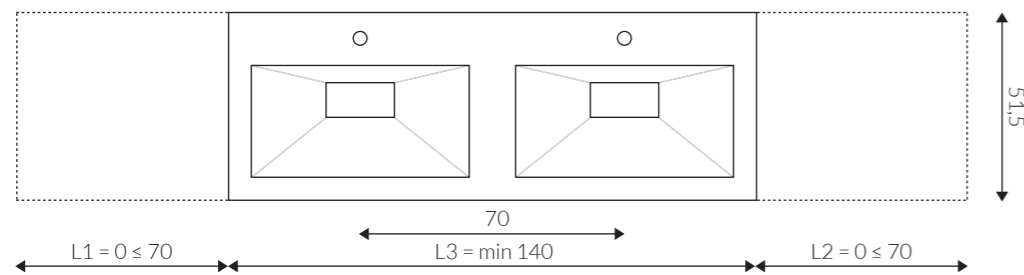

MISURE VASCA

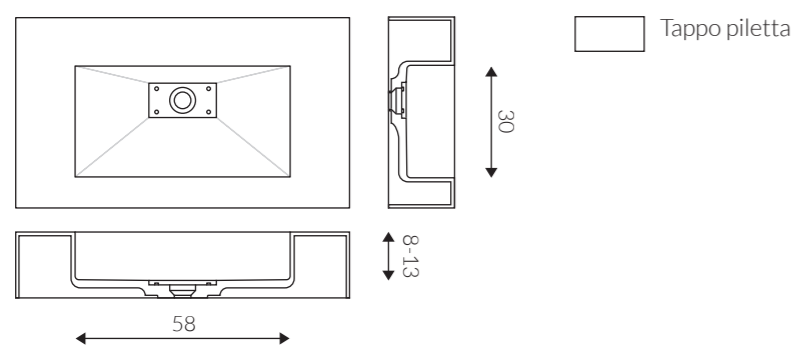

Accessori



Thin 50

TEXTURE



COLORI STANDARD



COLORI CUSTOM



Thin 50

Lavabo a consolle con vasca integrata.
Superficie liscia BIANCO (opaco/lucido) o COLORATO (opaco).
Disponibile con 1 vasca.
Disponibile nelle misure STANDARD.

Dimensioni (cm)

MISURE STANDARD LAVABO

Vasca CENTRALE

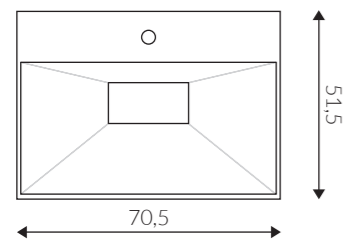

Vasca SX/DX

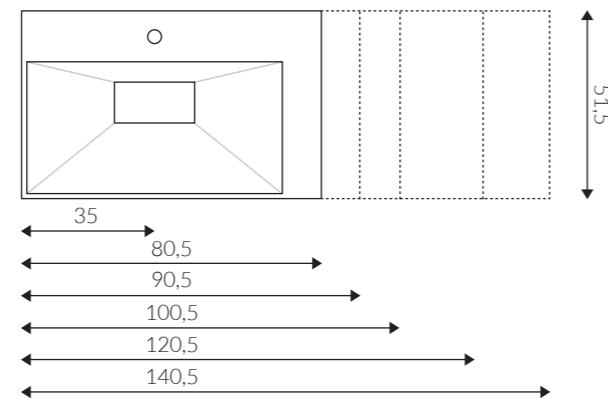

MISURE VASCA

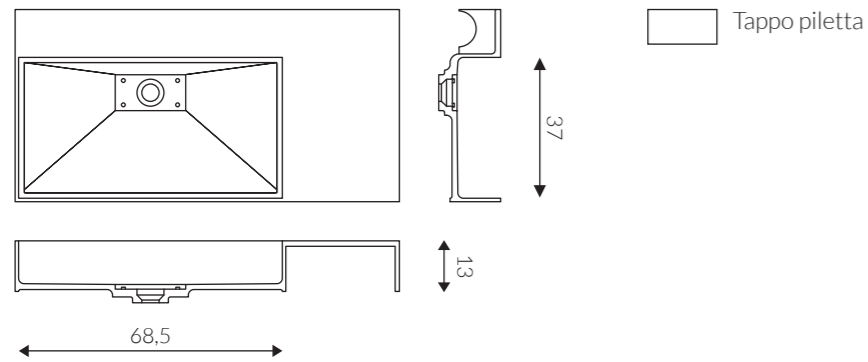

Accessori

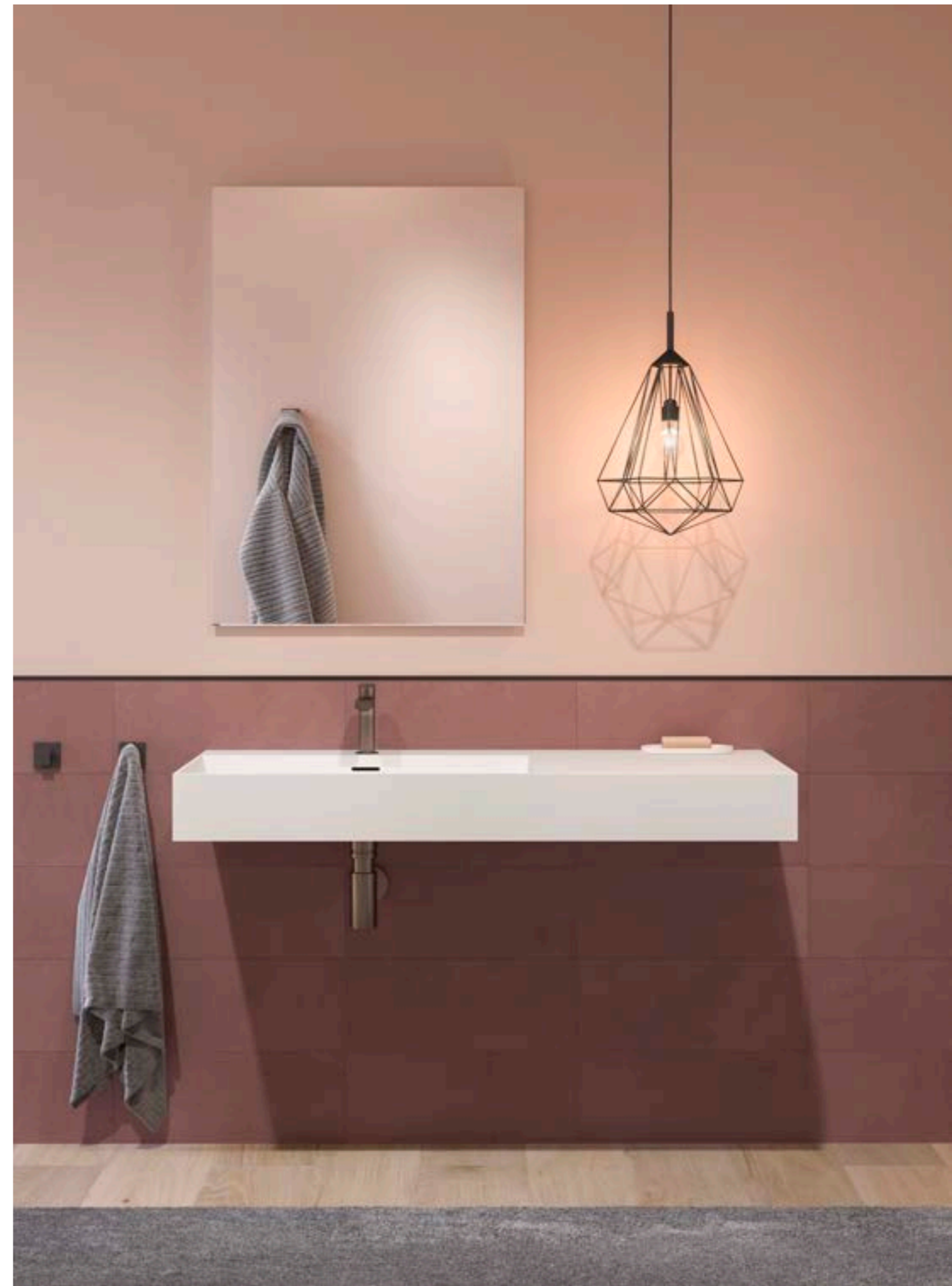

Thin 46

TEXTURE



SOFT

COLORI STANDARD



ANTRACITE
RAL 7043



URBAN
RAL 7006



TORTORA
RAL 1019



SABBIA
RAL 1013



GRIGIO
RAL 7047



BIANCO
RAL 9003

COLORI CUSTOM



RAL / NCS



Thin 46

Lavabo a consolle con vasca integrata.
Superficie liscia BIANCO (opaco/lucido) o COLORATO (opaco).
Disponibile con 1 vasca.
Disponibile nelle misure STANDARD.

Dimensioni (cm)

MISURE STANDARD LAVABO

Vasca SX

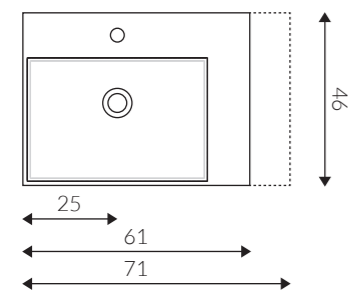

Vasca SX/DX

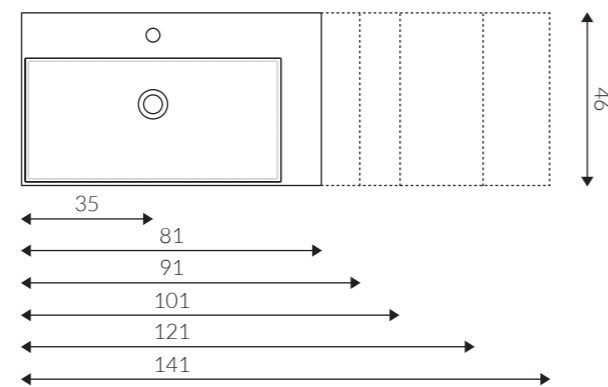

MISURE VASCA

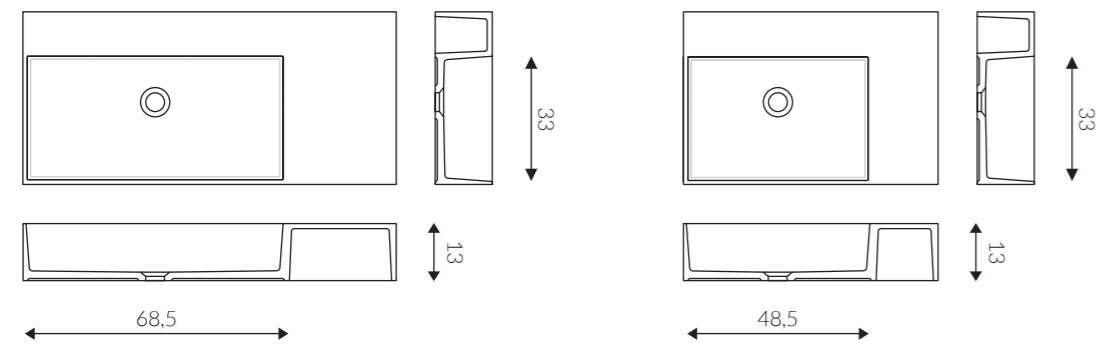

Accessori



Smash

TEXTURE

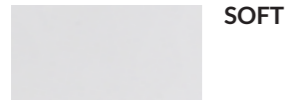

COLORI STANDARD



COLORI CUSTOM



Smash

Lavabo a consolle con vasca integrata.
Superficie liscia BIANCO (opaco/lucido) o COLORATO (opaco).
Disponibile con 1 vasca.
Disponibile nelle misure STANDARD.

Dimensioni (cm)

MISURE STANDARD LAVABO

Vasca CENTRALE

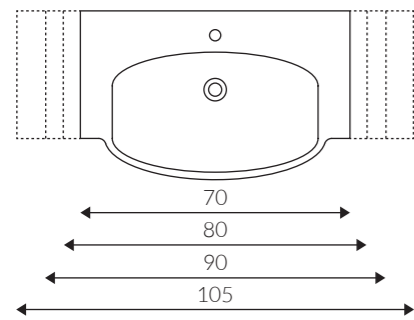

Vasca SX

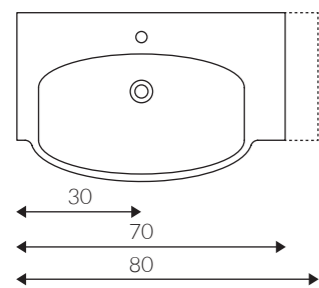

Vasca DX

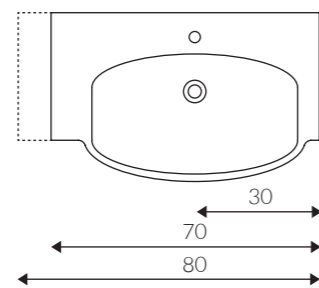

MISURE VASCA

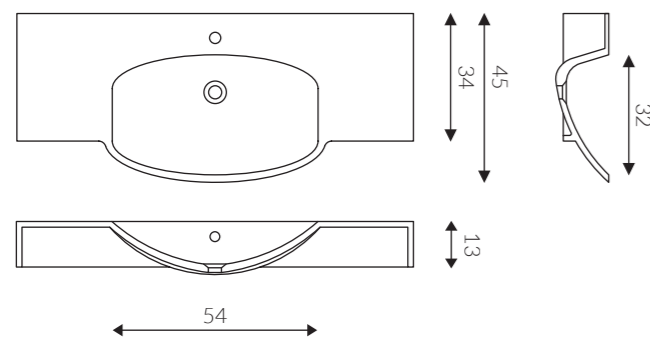

Accessori



Egeo

TEXTURE

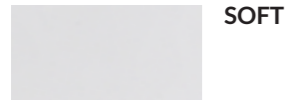

COLORI STANDARD



COLORI CUSTOM



Egeo

Lavabo sopra piano.

Superficie liscia BIANCO (opaco/lucido) o COLORATO (opaco).

Possibilità di montaggio su mensole di nostra produzione con forature scarico e rubinetto apposite.

Dimensioni (cm)

MISURE VASCA

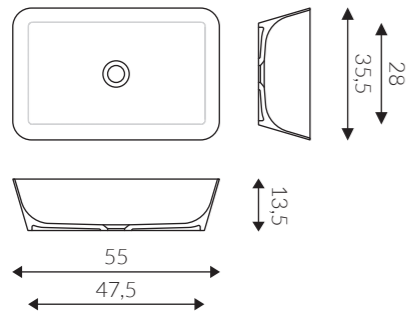

Accessori

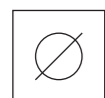

SENZA FORO
TROPPOPIENO



Devon

TEXTURE

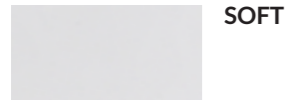

COLORI STANDARD



COLORI CUSTOM



Devon

Lavabo sopra piano.

Superficie liscia BIANCO (opaco/lucido) o COLORATO (opaco).

Possibilità di montaggio su mensole di nostra produzione con forature scarico e rubinetto apposite.

Dimensioni (cm)

MISURE VASCA

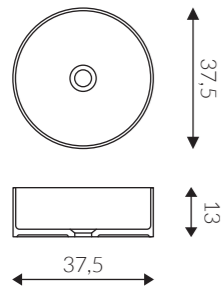

Accessori

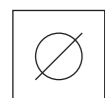

SENZA FORO
TROPPOPIENO



Leg

TEXTURE

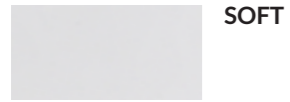

COLORI STANDARD



COLORI CUSTOM

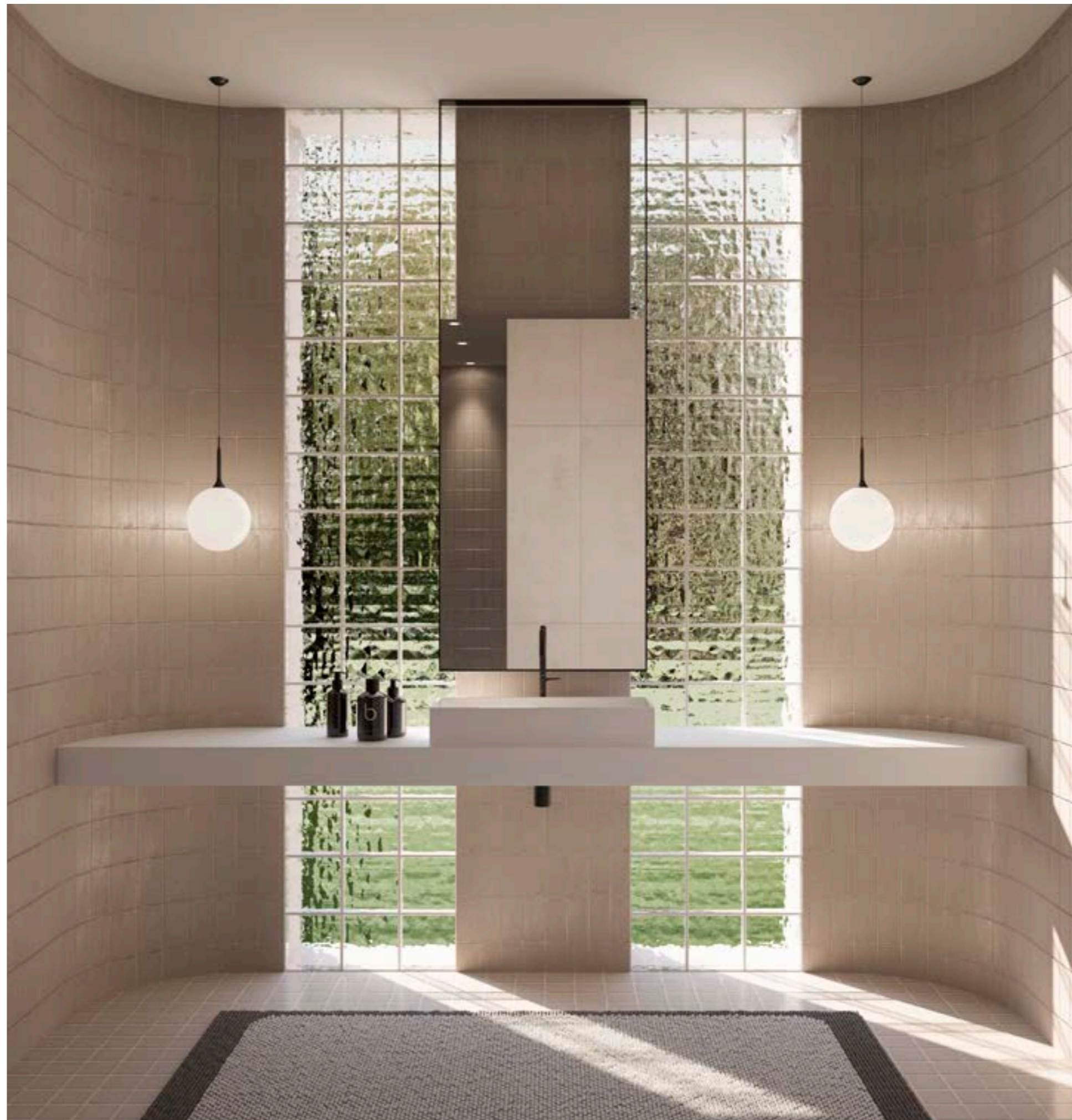

Leg

Lavabo sopra piano.

Superficie liscia BIANCO (opaco/lucido) o COLORATO (opaco).

Possibilità di montaggio su mensole di nostra produzione con forature scarico e rubinetto apposite.

Dimensioni (cm)

MISURE VASCA

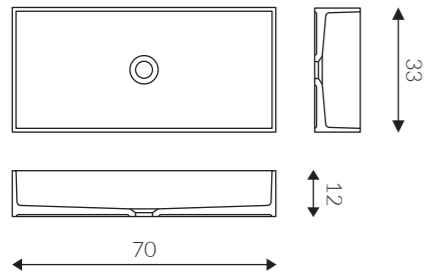

Accessori

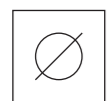

SENZA FORO
TROPPOPIENO

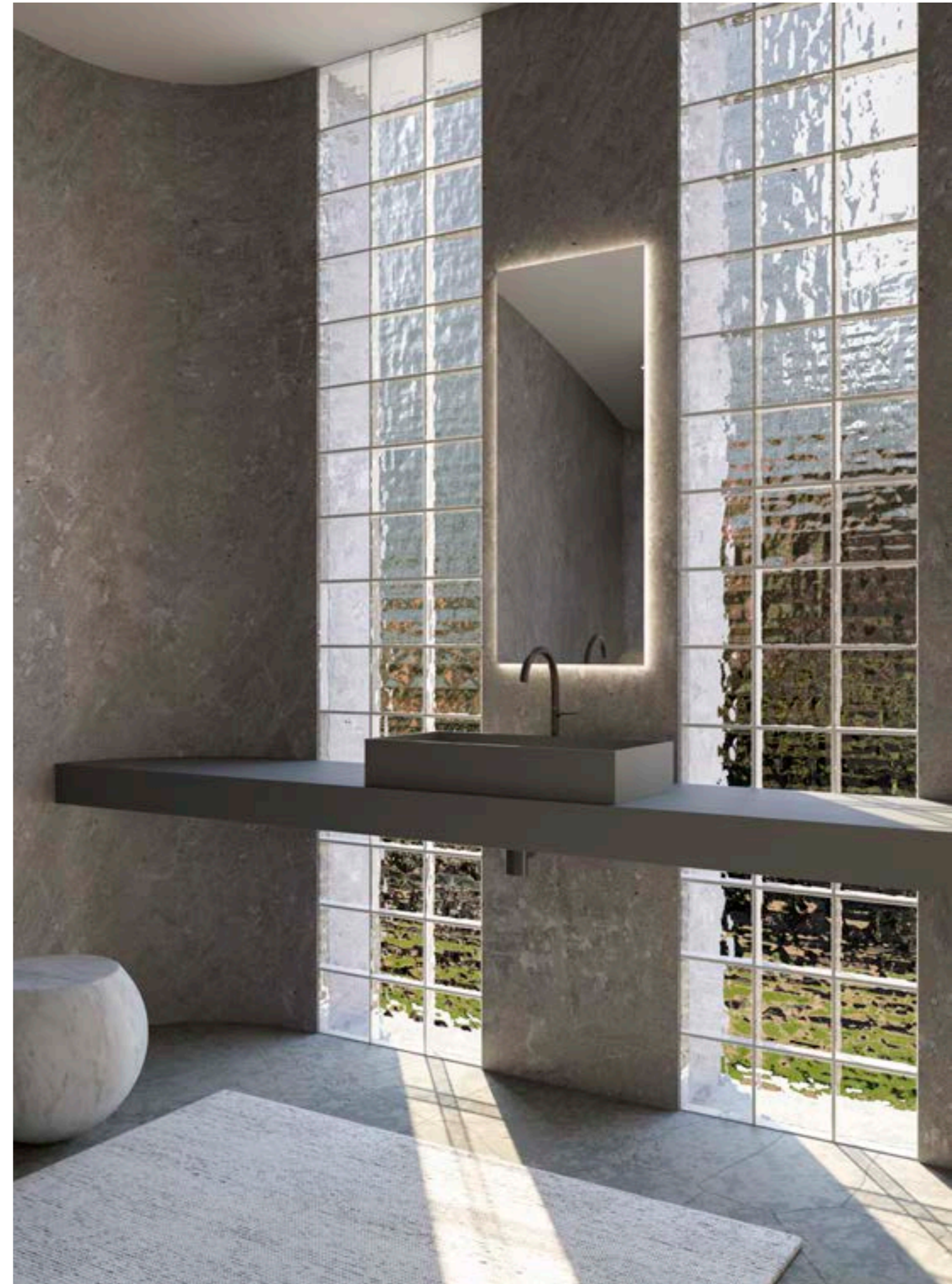

Ellipse

TEXTURE



COLORI STANDARD



COLORI CUSTOM



Ellipse

Lavabo sopra piano.

Superficie liscia BIANCO (opaco/lucido) o COLORATO (opaco).

Possibilità di montaggio su mensole di nostra produzione con forature scarico e rubinetto apposite.

Dimensioni (cm)

MISURE VASCA

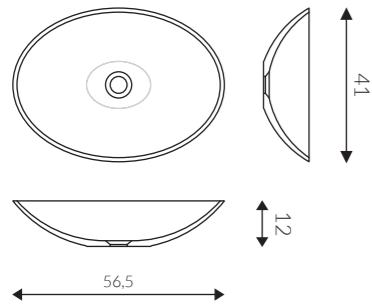

Accessori

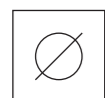

SENZA FORO
TROPPOPIENO



Circle

TEXTURE

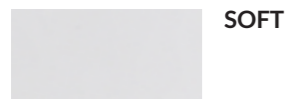

COLORI STANDARD



COLORI CUSTOM



Circle

Lavabo sopra piano.

Superficie liscia BIANCO (opaco/lucido) o COLORATO (opaco).

Possibilità di montaggio su mensole di nostra produzione con forature scarico e rubinetto apposite.

Dimensioni (cm)

MISURE VASCA

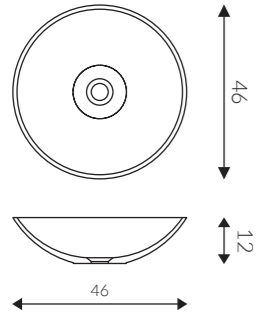

Accessori

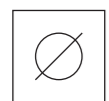

SENZA FORO
TROPPOPIENO



Luka

TEXTURE

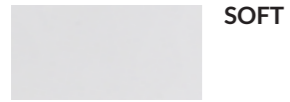

COLORI STANDARD



COLORI CUSTOM

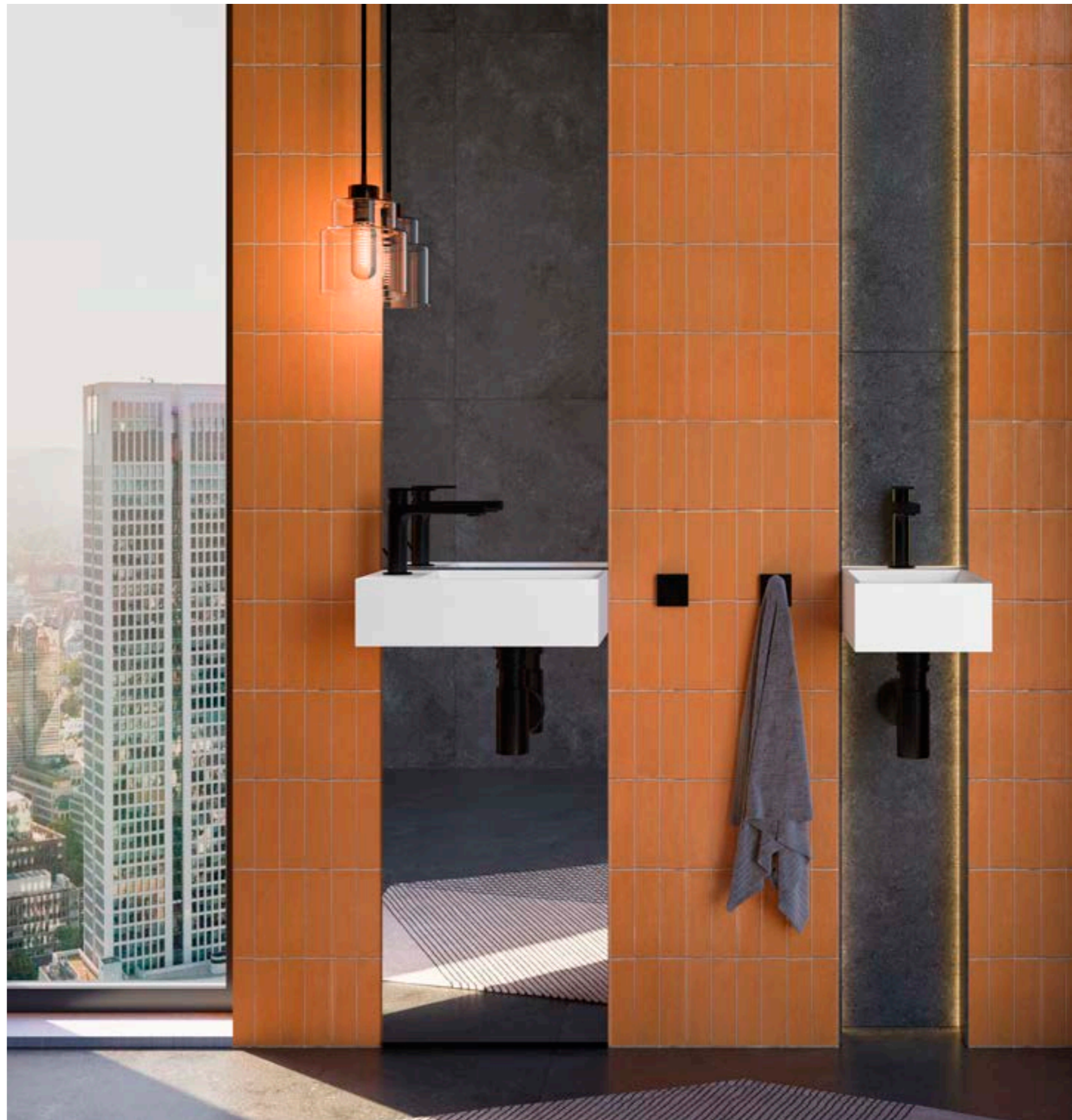

Luka

Lavabo sopra piano.

Superficie liscia BIANCO (opaco/lucido) o COLORATO (opaco).

Possibilità di montaggio su mensole di nostra produzione con forature scarico e rubinetto apposite.

Dimensioni (cm)

MISURE VASCA

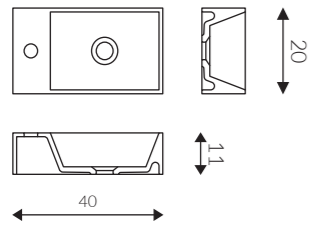

Accessori



Up&Down

TEXTURE



SOFT

COLORI STANDARD



ANTRACITE
RAL 7043



URBAN
RAL 7006



TORTORA
RAL 1019



SABBIA
RAL 1013



GRIGIO
RAL 7047



BIANCO
RAL 9003

COLORI CUSTOM



RAL / NCS



Up&Down

Lavabo semi-incasso.

Superficie liscia BIANCO (opaco/lucido) o COLORATO (opaco).

Possibilità di montaggio su mensole di nostra produzione con forature scarico e rubinetto apposite.

Dimensioni (cm)

MISURE VASCA

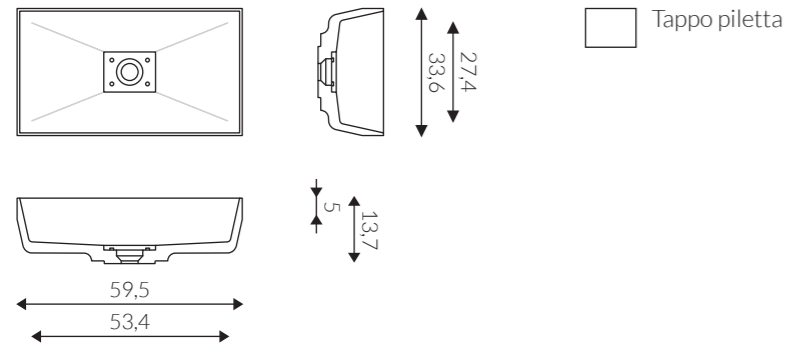

DETTAGLIO APPOGGIO SU PIANO

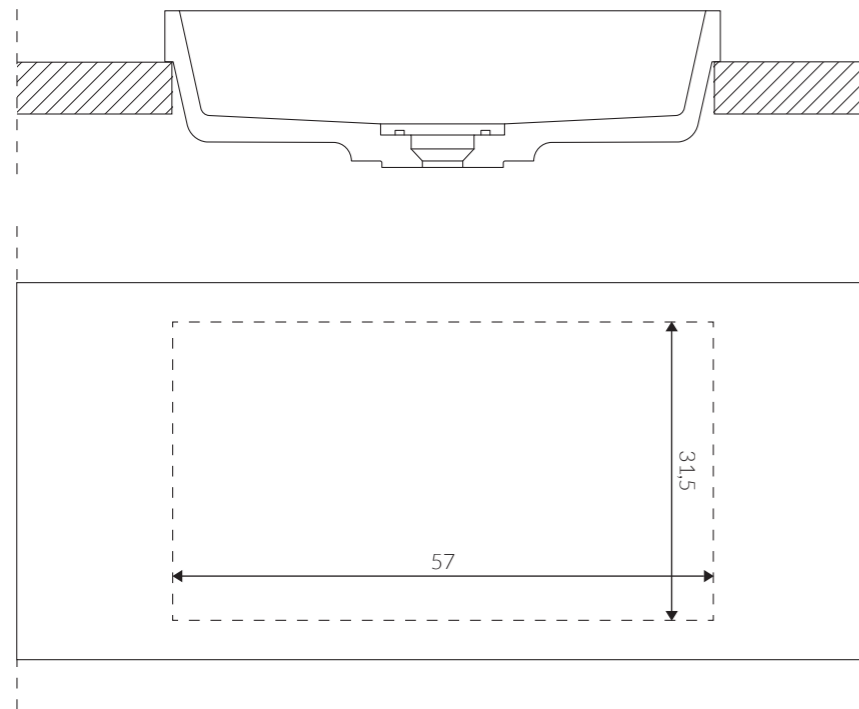

Accessori

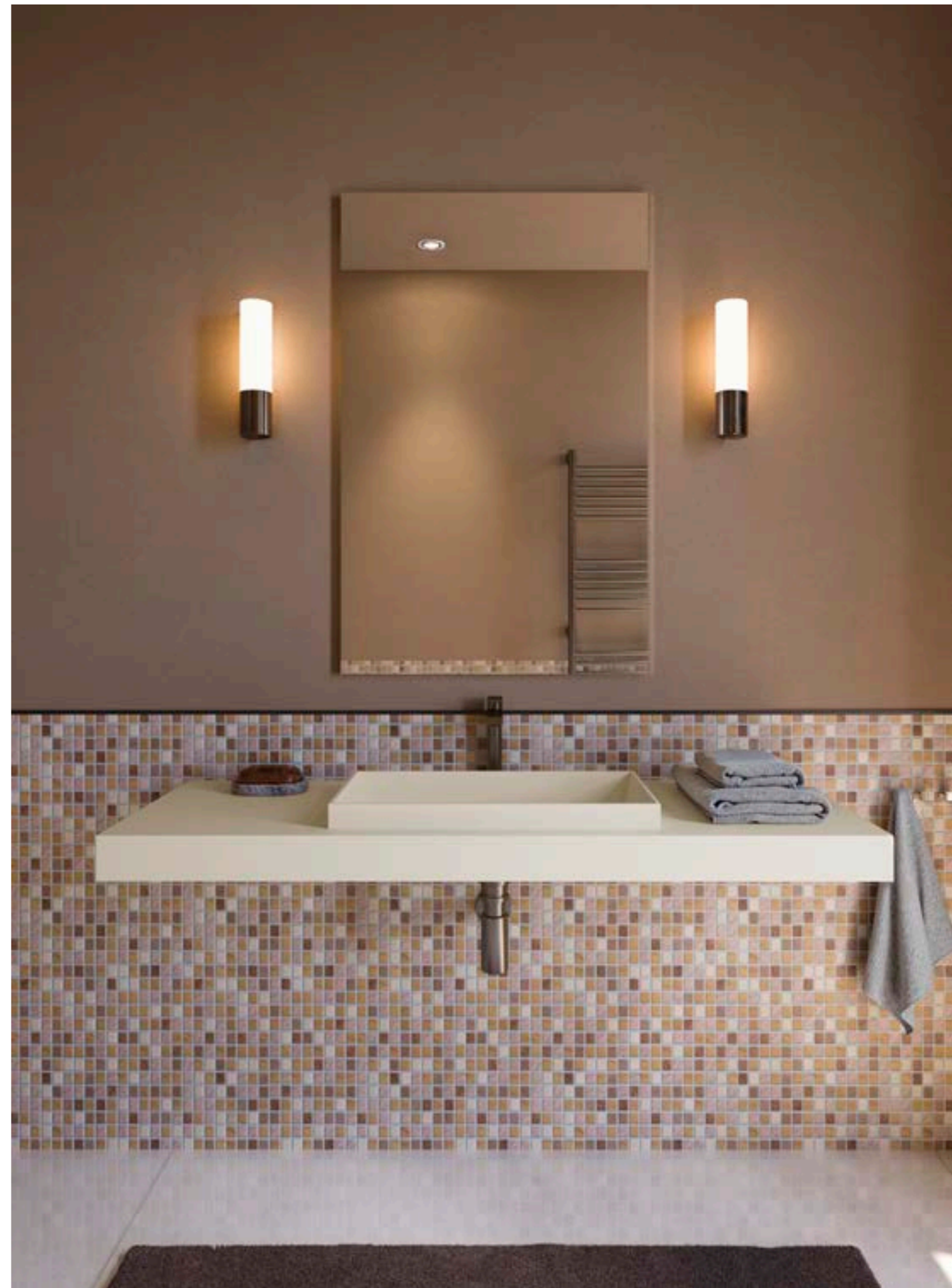

Mensole

TEXTURE



SOFT



CEMENTO

COLORI STANDARD



ANTRACITE
RAL 7043



URBAN
RAL 7006



TORTORA
RAL 1019



SABBIA
RAL 1013



GRIGIO
RAL 7047



BIANCO
RAL 9003

COLORI CUSTOM



RAL / NCS



Mensole

Mensole sospese da utilizzare con lavabi da appoggio o da sole.

Da realizzare completamente SU MISURA.

Superficie con texture CEMENTO, nei colori BIANCO (opaco) o COLORATO (opaco).

Superficie liscia BIANCO (opaco/lucido) o COLORATO (opaco).

Possibilità di realizzare fresature porta salviette, forature incasso lavabi, forature per scarichi e rubinetti.

Dimensioni (cm)

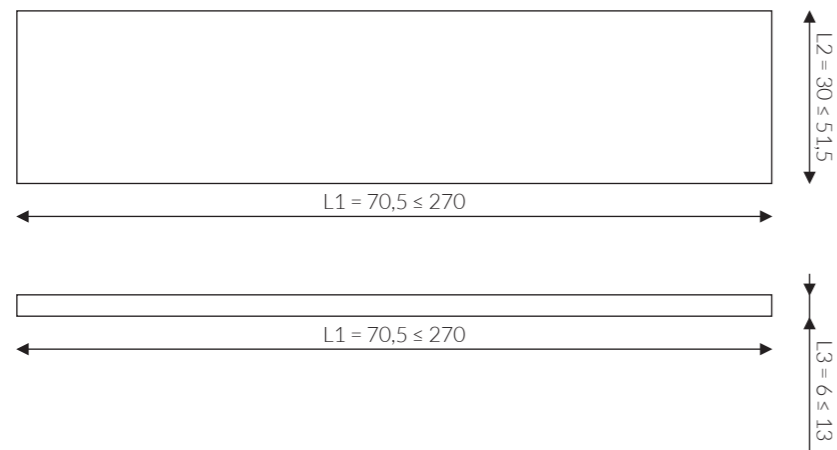

Fresatura portasciugamani su lato Dx o SX 3 x 35 cm

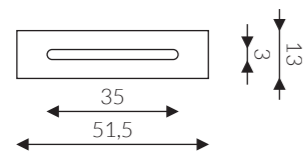

Fresatura portasciugamani frontale 3 x 35 cm

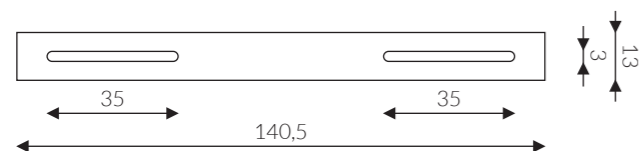

Accessori

Coppia staffe per lavabi



Kit scarico troppo pieno per lavabi

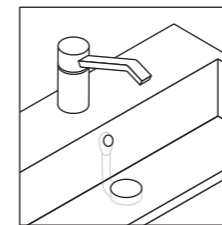

Tipologie di foro lavabo

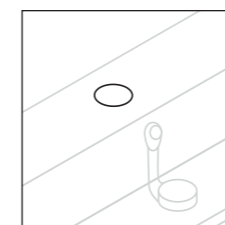

FORO RUBINETTO

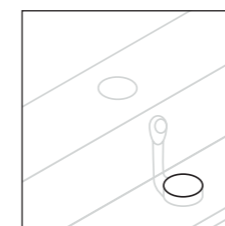

FORO ROTONDO
Ø 12 MM PER SCARICO

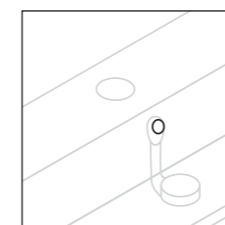

FORO INCASSO LAVABO
ROTONDO

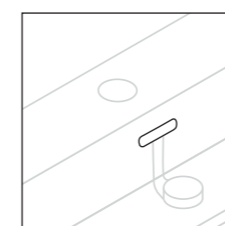

FORO INCASSO LAVABO
RETTANGOLARE

Tipologie di foro incasso lavabo

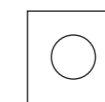

SOLO FORO ROTONDO

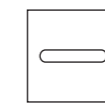

SOLO FORO FESSURA

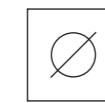

SENZA FORO

FINITURE E COLORI PLACCA PER FORO INCASSO



INOX LUCIDO
AISI 316



BIANCO
RAL 9003



Pannelli
da rivestimento

Pannelli da rivestimento

Superficie liscia SOFT, CEMENTO, DOLOMITE, ARDESIA, PIETRA.
Disponibile nella misure STANDARD o CUSTOM.

COLORI STANDARD



ANTRACITE
RAL 7043



URBAN
RAL 7006



TORTORA
RAL 1019



SABBIA
RAL 1013



GRIGIO
RAL 7047



BIANCO
RAL 9003

COLORI CUSTOM



RAL / NCS

TEXTURE



SOFT



ARDESIA



CEMENTO



PIETRA



DOLOMITE

DIMENSIONI (spessore 1,5 cm)

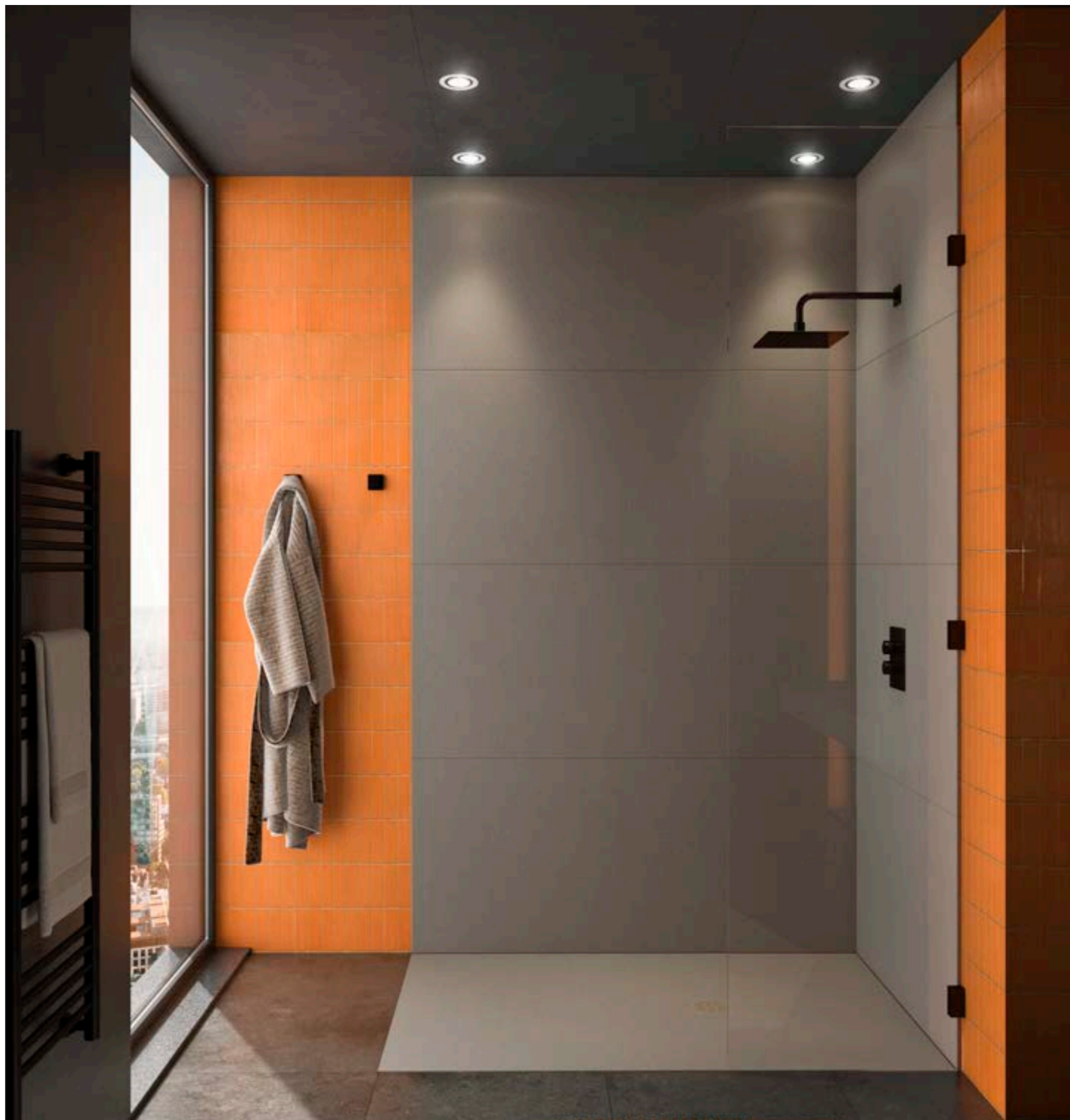
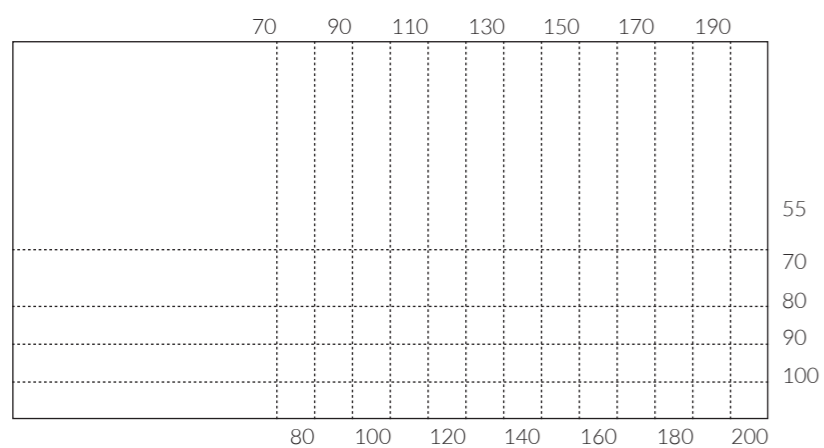

Sezione
tecnica

Imballaggio

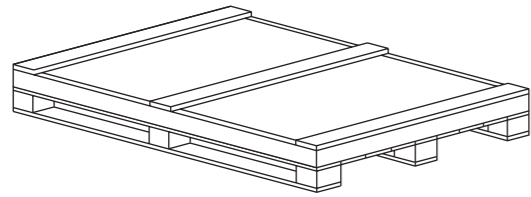

A Imballo singolo
In scatola di cartone inserita in gabbia di legno

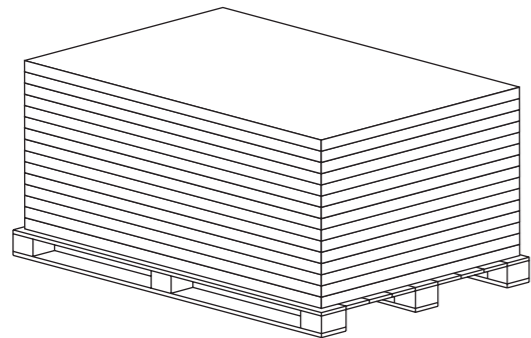

B Imballo orizzontale 15 pezzi
Imballo singolo in scatola di cartone su pallet

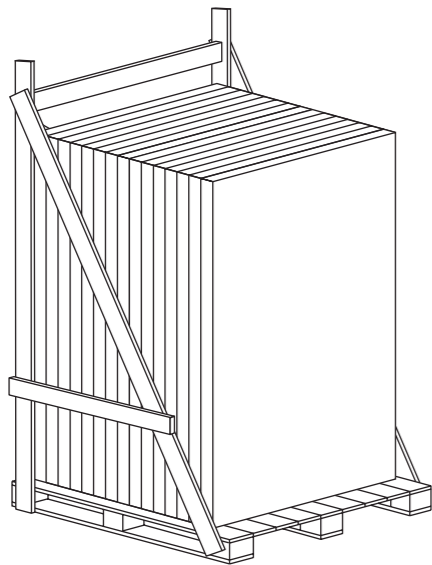

C Imballo verticale 15 pezzi - lato corto
Imballo singolo in scatola di cartone su pallet

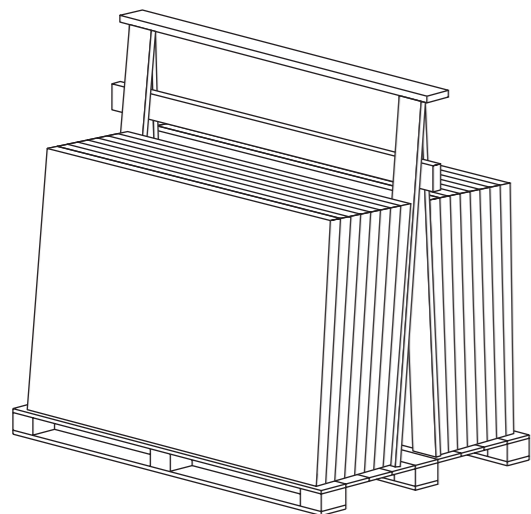

D Imballo verticale 15 pezzi - lato lungo
Imballo singolo in scatola di cartone su pallet

Informazioni tecniche

Composizione

I piatti doccia sono composti da resina termoindurente e cariche minerali naturali. I piatti doccia sono rivestiti da un film in Gelcoat ad elevata durezza e resistenza alle macchie. La superficie ha un effetto a rilievo che lo rende altamente antiscivolo.

Presenza misure

Effettuare la presa misure del piatto doccia considerando una tolleranza del materiale di circa +/- 1%.

Verifiche pre-installazione

Prima di procedere con l'installazione del piatto doccia verificare l'integrità del prodotto. Prima di posare il piatto doccia si deve procedere con il controllo della planarità dello stesso. Vista l'elasticità del materiale, un incurvamento fino 3 mm al metro lineare rientra nelle tolleranze. Nel caso in cui si verifichi un incurvamento superiore alle tolleranze, disporre il piatto doccia su un piano aggiungendo dei pesi sopra e degli spessori sotto per contrastare la curvatura e mantenerlo in questa posizione per circa 24 ore.

Prodotti per la posa

I piatti doccia si posano su massetto rasato utilizzando collanti elastici specifici. Si consiglia di effettuare l'impermeabilizzazione sotto il piatto doccia e per 10 cm di altezza sotto il rivestimento per evitare che nel tempo si creino infiltrazioni d'acqua dovute al naturale ritiro del silicone. Utilizzare il silicone lungo i 4 lati del piatto doccia.

Istruzioni per il taglio

I piatti doccia possono essere tagliati in posa utilizzando dischi diamantati. Si consiglia di tagliare i lati del piatto che vanno a muro sui quali va posato il rivestimento in modo da nascondere eventuali imprecisioni di taglio.

Pulizia e manutenzione

Per la pulizia quotidiana è sufficiente usare una spugna non abrasiva umida con acqua e detergente neutro (per essere sicuri che il detergente sia veramente neutro deve essere specificato sul flacone). Non utilizzare detergenti acidi, basi forti o solventi e non usare spugne abrasive sulla superficie del piatto doccia.

Istruzioni di montaggio

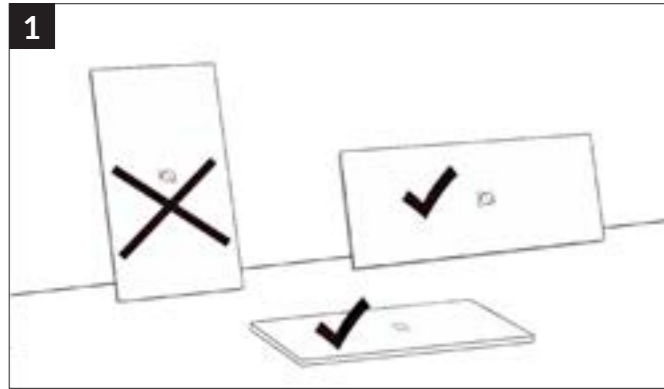

1 Nello stoccaggio dei piatti doccia fare attenzione a non appoggiarli in piedi sul lato corto perché a causa dell'elasticità del materiale con cui sono composti i piatti doccia possono incurvarsi.

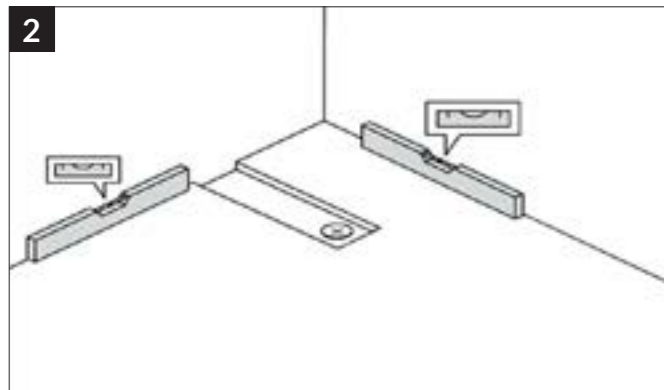

2 I piatti doccia si posano su massetto livellato, rasato e impermeabilizzato, non montare su piastrelle preesistenti.

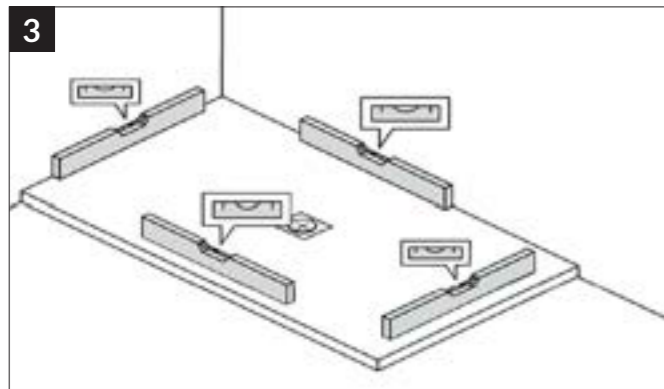

3 Posizionare il piatto in prova senza incollarlo verificando la bolla lungo i 4 lati.

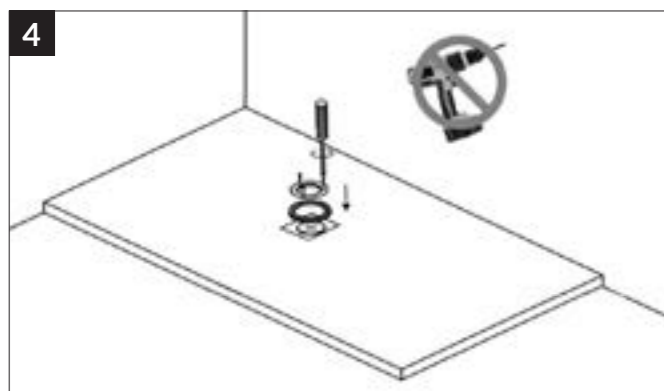

4 Montare la ghiera della piletta di scarico usando un cacciavite (non un trapano avvitatore).

Istruzioni di montaggio

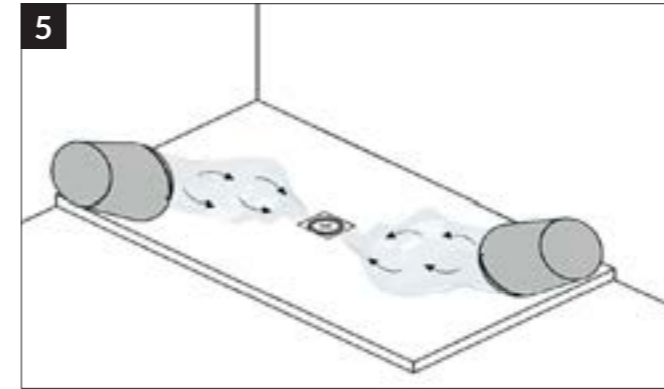

5 Rovesciando dell'acqua in tutte le direzioni verificare che l'acqua defluisca verso lo scarico.

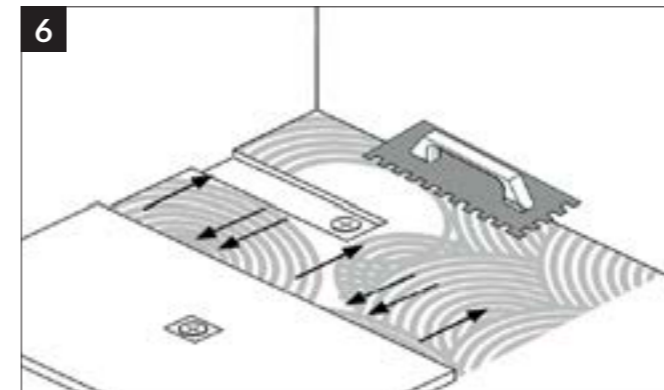

6 Se tutti i punti precedenti sono stati soddisfatti procedere all'incollaggio del piatto doccia utilizzando collanti elastici da piastrelle.

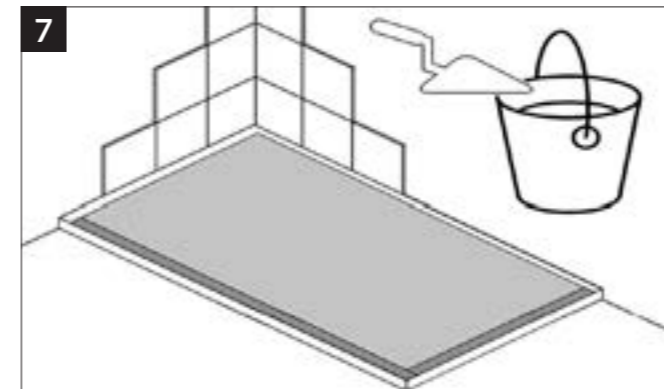

7 Prima di procedere al montaggio del rivestimento proteggere il piatto doccia utilizzando cartone o Nylon per evitare che i collanti utilizzati cadano sul piatto doccia. Lasciare una fuga di almeno 3 mm tra il piatto doccia e la prima fila di piastrelle.

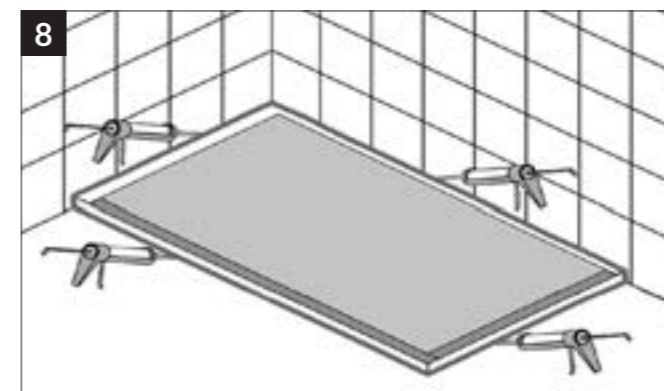

8 Siliconare le fughe lungo i 4 lati del piatto doccia.

Note

La garanzia decade qualora le istruzioni sopra descritte non siano state eseguite correttamente e nel caso in cui la garanzia venga accordata, prevede il rimborso del valore del piatto doccia.

Certificazioni CE

Rapporti di prova UNI-EN

TITOLO NORMA	NUMERO NORMA	REQUISITO NORMA	VALUTAZIONE
Piatti doccia per impieghi domestici <i>Generalità</i>	UNI EN 14527:2010	Il fabbricante deve fornire istruzioni riguardanti l'installazione e la manutenzione	Il cliente fornisce le istruzioni di installazione, uso e manutenzione per il piatto doccia
Piatti doccia per impieghi domestici <i>Pulibilità: aspetto della superficie</i>	UNI EN 14527:2010	Le superfici del piatto doccia devono essere visibilmente lisce, non assorbenti e prive di angoli inaccessibili che ne comprometterebbero la pulibilità	Il piatto doccia non presenta difetti o deformazioni che ne compromettono la pulibilità
Piatti doccia per impieghi domestici <i>Pulibilità: Scarico dell'acqua</i>	UNI EN 14527:2010 Foro di scarico conforme secondo UNI EN 251:2012	Tutta l'acqua deve essere scaricata dal piatto doccia, a meno che non sia trattenuta dalla tensione superficiale	L'acqua fuoriesce dallo scarico. Il cliente ha fornito piletta e raccordi piatto doccia.
Piatti doccia per impieghi domestici <i>Requisiti per prodotti: stabilità del fondo</i>	UNI EN 14527:2010	Il piatto doccia non deve avere deformazioni permanenti o altri difetti tali che ne ostacolerebbero lo svuotamento dell'acqua	Il piatto doccia non presenta deformazioni permanenti o altri difetti tali che ne ostacolerebbero lo svuotamento dell'acqua
Piatti doccia per impieghi domestici <i>Durabilità: Resistenza alle variazioni di temperatura</i>	UNI EN 14527:2010	I piatti doccia non devono presentare segni di deformazione o altri difetti come screpolature che ne compromettano la pulibilità	Il piatto doccia non presenta difetti che ne compromettano la pulibilità
Piatti doccia per impieghi domestici <i>Marcatura, etichettatura e imballaggio</i>	UNI EN 14527:2010	Il piatto doccia deve essere etichettato con la norma di riferimento e la classe del piatto doccia	Conforme
Piatti doccia per impieghi domestici <i>Durabilità: Resistenza alle sostanze chimiche e agli agenti macchianti</i>	UNI EN 14527:2010	I piatti doccia non devono riportare deterioramenti superficiali permanenti quali macchie o deterioramenti non eliminabili con acqua o l'agente abrasivo specificato	I piatti doccia non presentano deterioramenti superficiali permanenti

Tabella prestazionale

Resistenza alle sostanze chimiche di uso comune

CATEGORIA	SOSTANZA	TEMPO DI ESPOSIZIONE	LIVELLO DI USURA
ACIDI	ACETO DI VINO	10 h	A
ACIDI	ANTICALCARE	10 h	A
ALCALI	DETERGENTE GENERICO	10 h	A
ALCALI	SGRASSATORI	10 h	A
ALCALI	AMMONIACA	10 h	A
ALCOLI	LAVAVETRI	10 h	A
ALCOLI	ACETONE	10 h	A
ALCOLI	ALCOL	10 h	A
SBIANCANTI	CANDEGGINA	2 h	A
SBIANCANTI	ACQUA OSSIGENATA	10 h	A
AGENTI MACCHIANTI	IODIO	1 h	A
AGENTI MACCHIANTI	BLU DI METILENE	1 h	A
AGENTI MACCHIANTI	TINTURA PER CAPELLI (COLORE MEDIO)	1 h	A
AGENTI MACCHIANTI	TINTURA PER CAPELLI (COLORE SCURO)	1 h	A
AGENTI MACCHIANTI	OLI VEGETALI DI CONSUMO	10 h	A
AGENTI MACCHIANTI	MERCUROCROMO	1 h	A
AGENTI MACCHIANTI	SUCCO DI FRUTTA	10 h	A
AGENTI MACCHIANTI	CAFFÈ	10 h	A
AGENTI MACCHIANTI	VINO ROSSO	10 h	A
AGENTI MACCHIANTI	ROSSETTO	10 h	A
AGENTI MACCHIANTI	INCHIOSTRO	10 h	A
AGENTI MACCHIANTI	PENNARELLO INDELEBILE	10 h	A
AGENTI MACCHIANTI	PENNA	10 h	A
AGENTI MACCHIANTI	MATITA	10 h	A

Il sistema di classificazione si basa sul codice seguente:

- A:** senza cambiamenti importanti visibili
- B:** leggeri cambiamenti di colore visibili
- C:** moderati cambiamenti di colore visibili
- D:** importanti cambiamenti di colore visibili

Finiture

PIETRA



DOLOMITE



CEMENTO



SOFT



ARDESIA

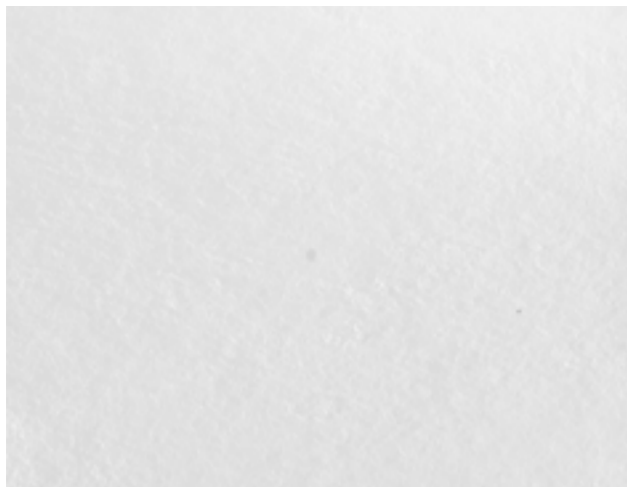

www.riverstone.it



Poliflex srl
Via del Commercio Nord, 69
56034 Casciana Terme (PI)
TEL +39 0587 646404
www.riverstone.it

