

Reno

Superficie effetto PIETRA.
Scarico in posizione centrale.
Piletta standard diametro 9 cm.



COLORI STANDARD

	ANTRACITE RAL 7043
	URBAN RAL 7006
	TORTORA RAL 1019
	SABBIA RAL 1013
	GRIGIO RAL 7047
	BIANCO RAL 9003

MISURE STANDARD

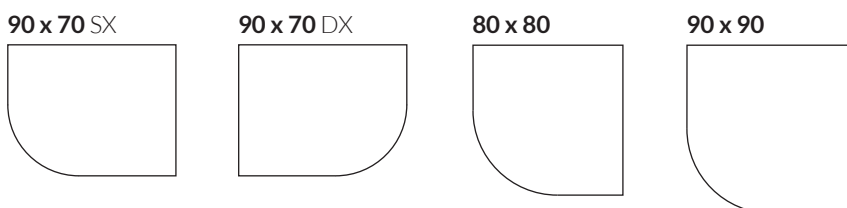

COLORI CUSTOM

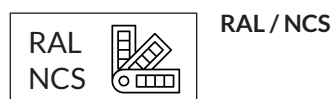

TEXTURE



Griglia

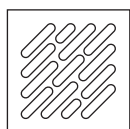

Misura	INOX	STANDARD	RAL / NCS
12,5 x 12,5 cm	✓	✓	✓

Scarichi (mm)

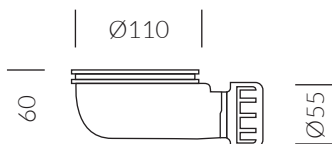

Scarico standard

La piletta va sempre posizionata lato muro.

Tagli su misura

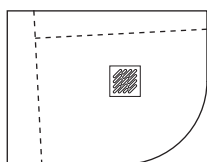

TAGLIO DIAGONALE

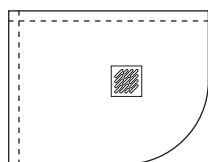

SQUADRATURA DRITTA

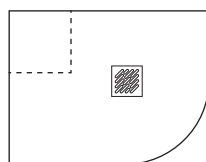

SCASSO COLONNA

LA RAGGIATURA È FISSA

Bordi - NON possono essere aggiunti bordi

Zoccoli per piatti a gradino - NON possono essere applicati

Classe antiscivolo

Normativa DIN 51097: A+B+C

Note

Le immagini sono da intendersi a scopo illustrativo e non costituiscono vincolo contrattuale. In caso di installazione di box doccia walk-in, con almeno un lato aperto, è consigliata l'aggiunta di un bordo per limitare la fuoriuscita d'acqua. Maggiori informazioni sono disponibili nella sezione "Bordi".

Dimensioni (cm)

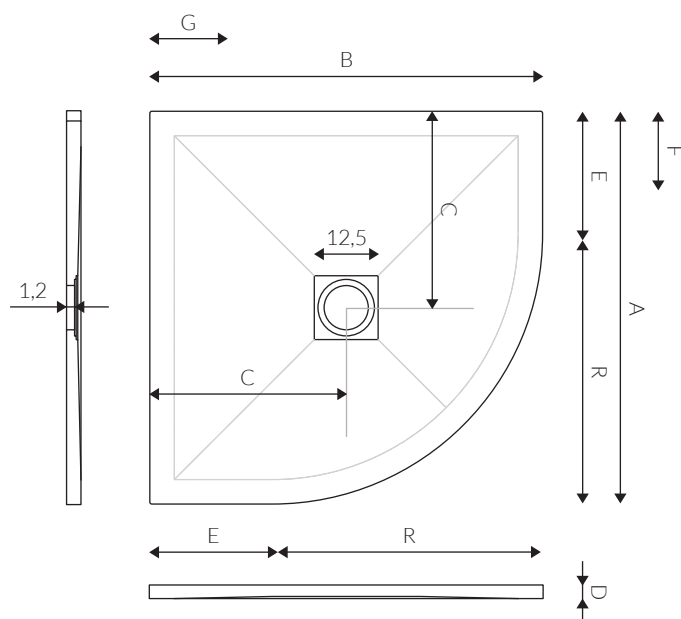

B 70						
A	C	D	E	F	G	R (DX - SX)
90	35/45	2,5	52/32	5	5	38

B 80						
A	C	D	E	F	G	R
80	40	2,5	25	5	5	55

B 90						
A	C	D	E	F	G	R
90	45	2,7	35	5	5	55