

# Arno

Superficie antiscivolo effetto DOLOMITE.

Scarico in posizione decentrata.

Piletta standard diametro 9 cm.

Disponibile in una gamma di misure molto ampia per garantire la massima adattabilità.



Può essere tagliato su 4 lati.



## COLORI STANDARD

	<b>ANTRACITE</b> RAL 7043
	<b>URBAN</b> RAL 7006
	<b>TORTORA</b> RAL 1019
	<b>SABBIA</b> RAL 1013
	<b>GRIGIO</b> RAL 7047
	<b>BIANCO</b> RAL 9003

## MISURE STANDARD

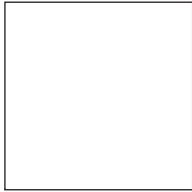
70 x	80 x	90 x	100 x
			
80	80	90	100
90	90	100	110
100	100	110	120
110	110	120	130
120	120	130	140
130	130	140	150
140	140	150	160
150	150	160	170
160	160	170	180
170	170	180	190
180	180	190	200
190	190	200	
200	200		

## COLORI CUSTOM

	<b>RAL / NCS</b>
--	------------------

## TEXTURE

	<b>DOLOMITE</b>
--	-----------------

## Griglia

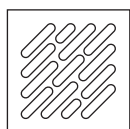

Misura	INOX	STANDARD	RAL / NCS
12,8 x 12,8 cm	✓	✓	✓

## Scarichi (mm)

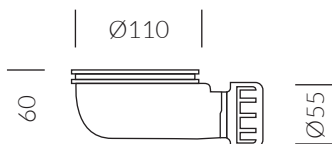

### Scarico standard

La piletta va sempre posizionata lato muro.

## Tagli su misura

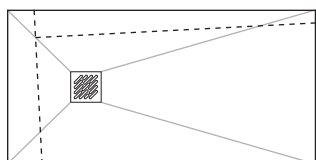

TAGLIO DIAGONALE

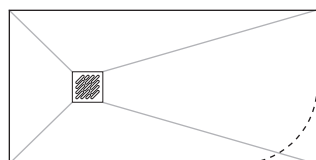

RAGGIATURA

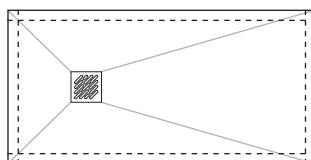

SQUADRATURA DRITTA

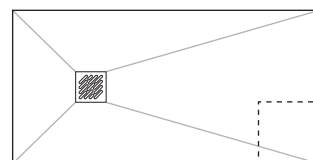

SCASSO COLONNA

## Bordi

Spessore bordo 4 cm

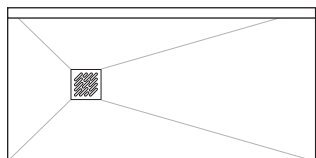

AGGIUNTA BORDO 1 LATO

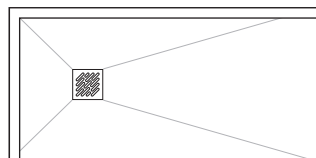

AGGIUNTA BORDO 2 LATI

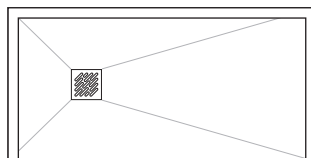

AGGIUNTA BORDO 3 LATI

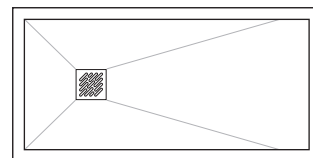

AGGIUNTA BORDO 4 LATI

## Zoccoli per piatti a gradino

Spessore su misura

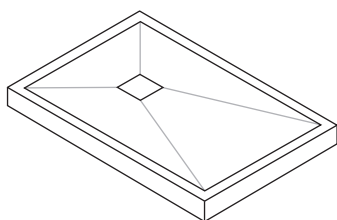

## Classe antiscivolo

Normativa DIN 51097: A+B

## Note

Le immagini sono da intendersi a scopo illustrativo e non costituiscono vincolo contrattuale. In caso di installazione di box doccia walk-in, con almeno un lato aperto, è consigliata l'aggiunta di un bordo per limitare la fuoriuscita d'acqua. Maggiori informazioni sono disponibili nella sezione "Bordi".

## Dimensioni (cm)

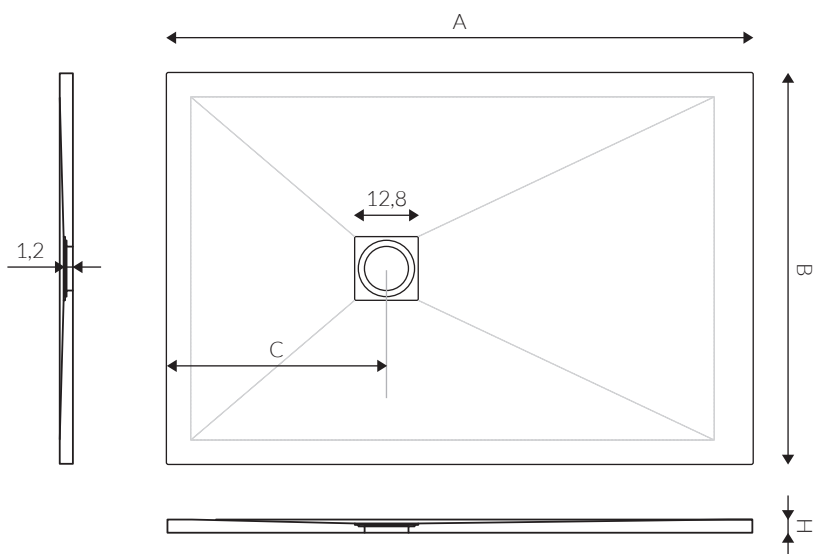

B 70			B 80			B 90			B 100		
A	C	H	A	C	H	A	C	H	A	C	H
80	35	2,2	80	35	2,2	-	-	-	-	-	-
90	35	2,2	90	35	2,2	90	35	2,2	-	-	-
100	35	2,2	100	35	2,2	100	44	2,2	100	44	2,2
110	44	2,2	110	44	2,2	110	44	2,2	110	44	2,2
120	44	2,2	120	44	2,2	120	44	2,2	120	44	2,2
130	44	2,4	130	44	2,4	130	35	2,4	130	35	2,4
140	44	2,4	140	44	2,4	140	35	2,4	140	35	2,4
150	44	2,5	150	44	2,5	150	44	2,5	150	50	2,5
160	44	2,6	160	44	2,6	160	50	2,6	160	50	2,6
170	44	2,6	170	44	2,6	170	50	2,6	170	50	2,6
180	44	2,6	180	44	2,6	180	44	2,6	180	50	2,6
190	50	2,6	190	50	2,6	190	50	2,6	190	50	2,6
200	50	2,8	200	50	2,8	200	50	2,8	200	50	2,8